



TP-2

Dual channel universal Temperature / Pressure Gauge

Operating Manual – English 1.00



Introduction

The TP-2 is a 3 1/8" dual channel temperature/pressure gauge with universal inputs that can interface to many sensors such as oil temperature, coolant temperature, oil pressure, fuel pressure, manifold pressure, boost pressure and many more.

The TP-2 gauge can be setup for a single, dual or combination temperature / pressure display.

Temperature can be measured using standard automotive resistive senders (e.g. VDO) as well as the MGL Avionics precision LM335 semiconductor sensor. Pressure can be measured using standard automotive resistive senders (e.g. VDO), Rotax 4-20mA senders as well as 0-5V output pressure senders (e.g. UMA). In addition the temperature and pressure inputs can be programmed to a user defined curve for custom senders.

Both the temperature and pressure readings have a programmable low and high alarm. This results in a contact closure that is typically used to switch a warning lamp on. The TP-2 also records the maximum temperature and pressure values reached in permanent memory.

1 Features

- Dual channel universal input temperature and pressure gauge
- Temperature can be measured using standard automotive resistive senders (e.g. VDO) as well as the MGL Avionics precision LM335 semiconductor sensor
- Pressure can be measured using standard automotive resistive senders (e.g. VDO), Rotax 4-20mA senders as well as 0-5V output pressure senders (e.g. UMA)
- Temperature and pressure inputs can be programmed to a user defined curve for custom senders
- Can be setup for a single, dual or combination temperature / pressure display.
- Both temperature and pressure readings have a programmable low and high alarm
- Records maximum temperature and pressure reached in permanent memory
- Supports Rotax 4-20mA pressure sender as used in 912/914 engines
- Standard 3 1/8" aircraft enclosure (can be front or rear mounted)
- Rotary control plus 2 independent buttons for easy menu navigation and user input
- External alarm output as well as a red LED illuminates when the alarm has been activated
- Large backlit graphic LCD with adjustable contrast
- Wide input supply voltage range of 8 to 30V DC with built in voltage reversal and over voltage protection for harsh electrical environments
- Light weight design
- 1 year limited warranty

2 TP-2 Layout

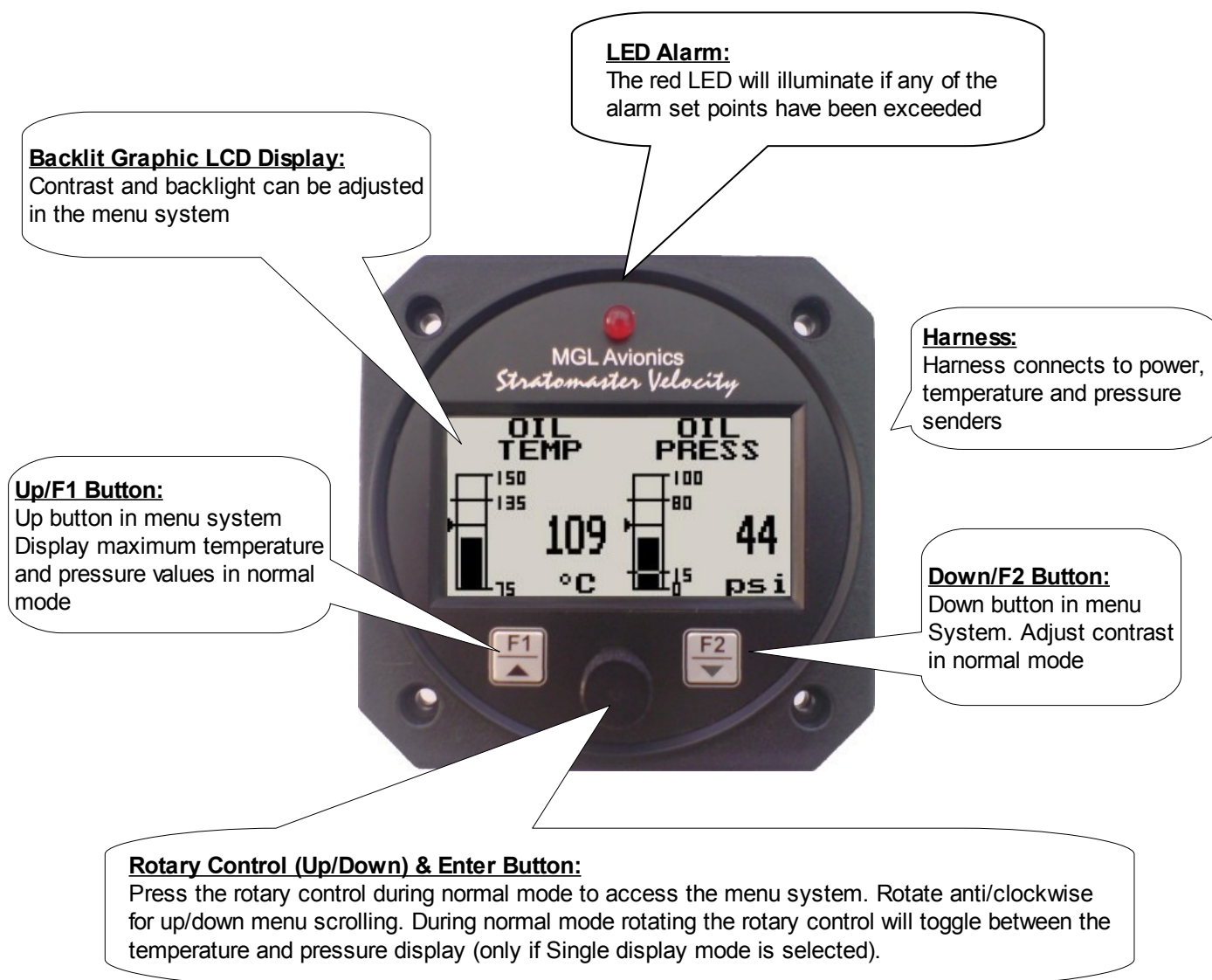

3 Main Display

The TP-2 has 4 different temperature/pressure display screens. These screens can be setup under the “DISPLAY SETUP” menu option. The display can be setup to display pressure and temperature as vertical or horizontal bar graphs as well as dual or single displays. If the TP-2 is setup to display single values then rotating the rotary control will toggle between the temperature and pressure displays.

Display Mode 1: Dual/Vertical mode

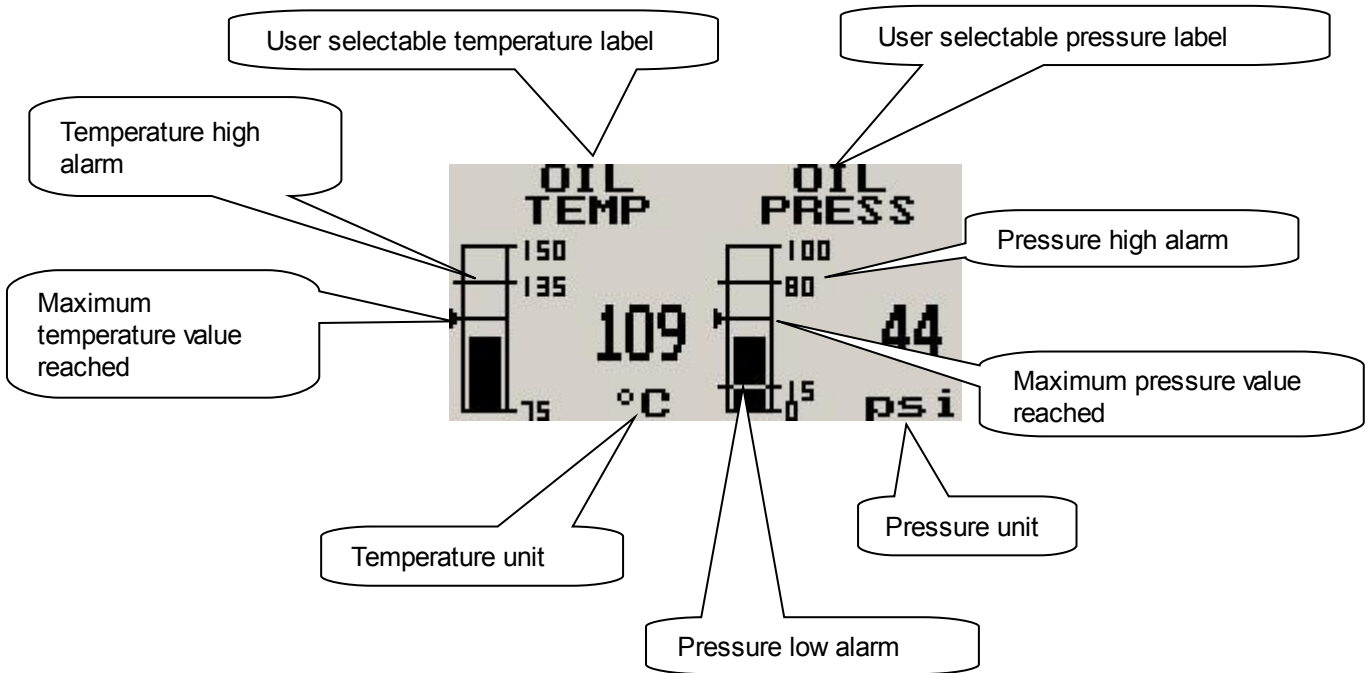

Display Mode 2: Dual/Horizontal mode

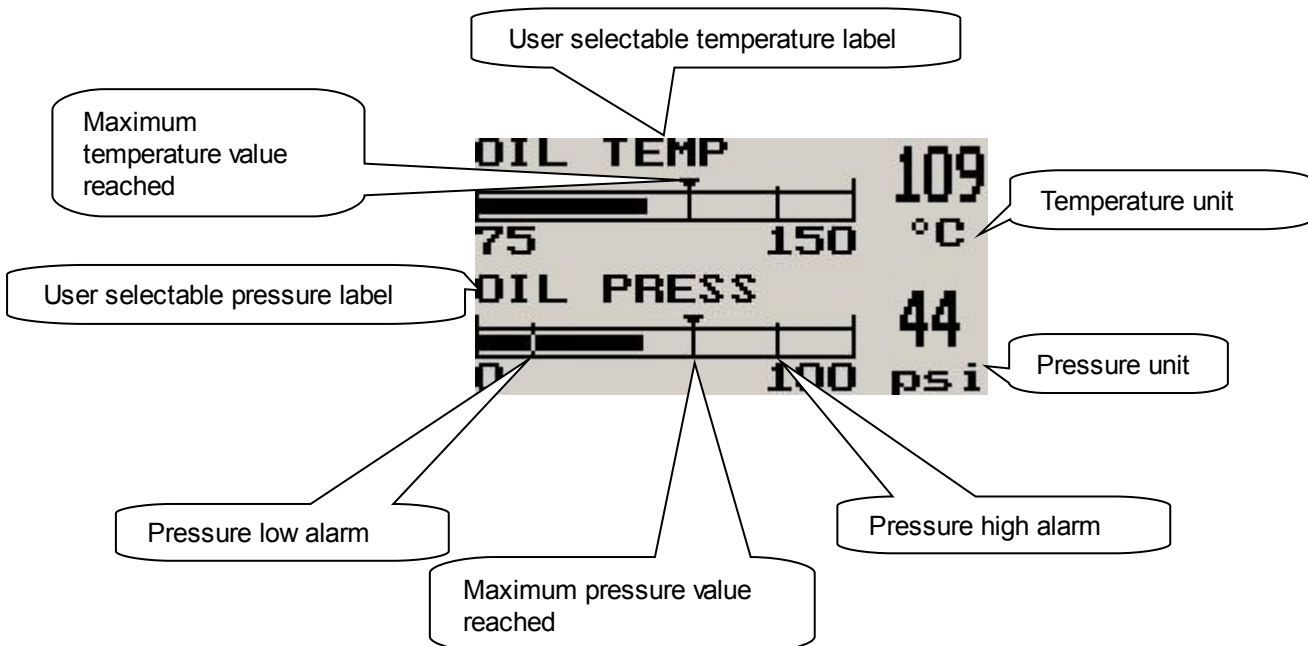

Display Mode 3: Single/Vertical mode

You can toggle between temperature and pressure by rotating the rotary control.

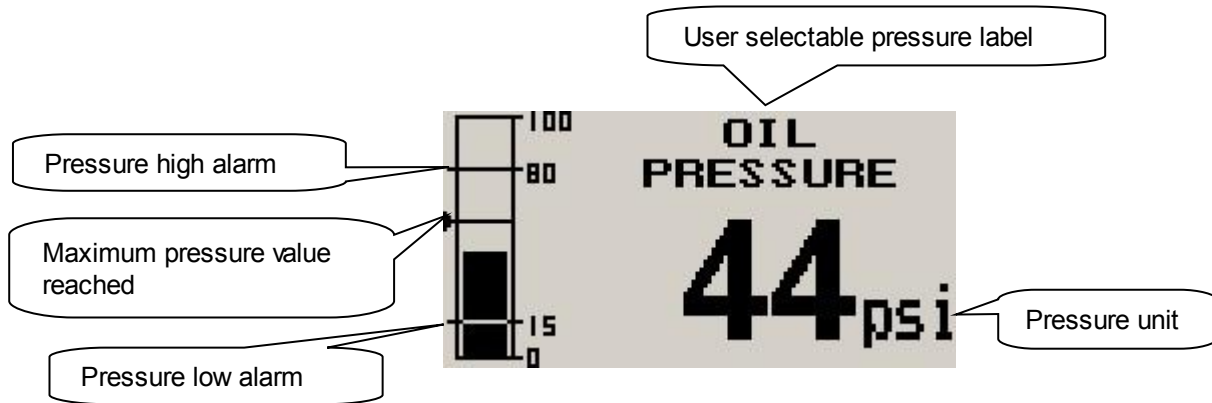
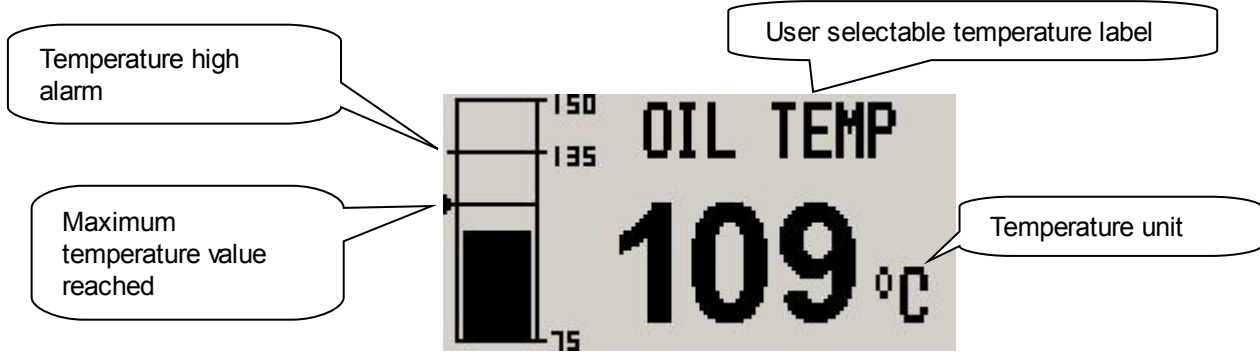

Display Mode 4: Single/Horizontal mode

You can toggle between temperature and pressure by rotating the rotary control.

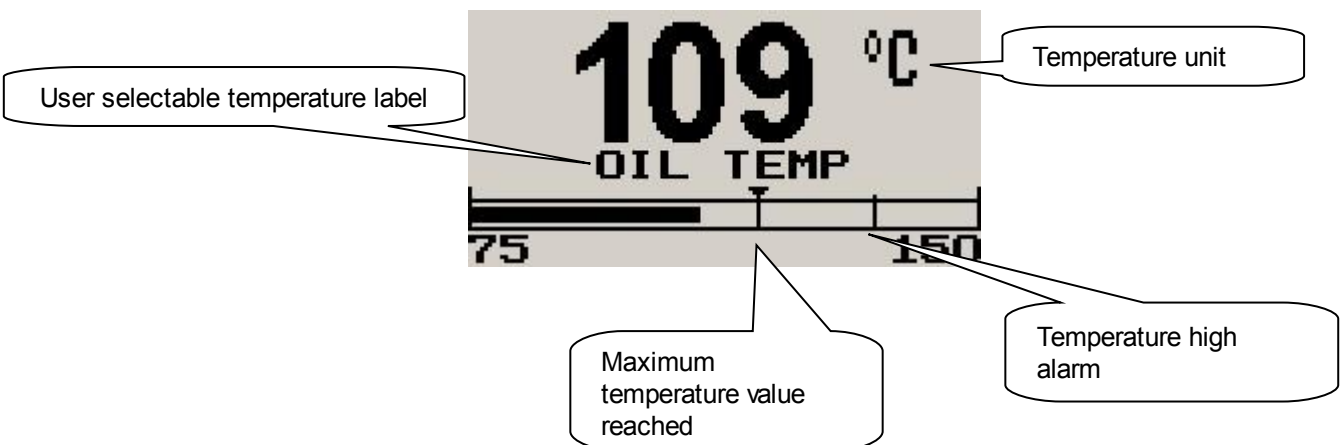

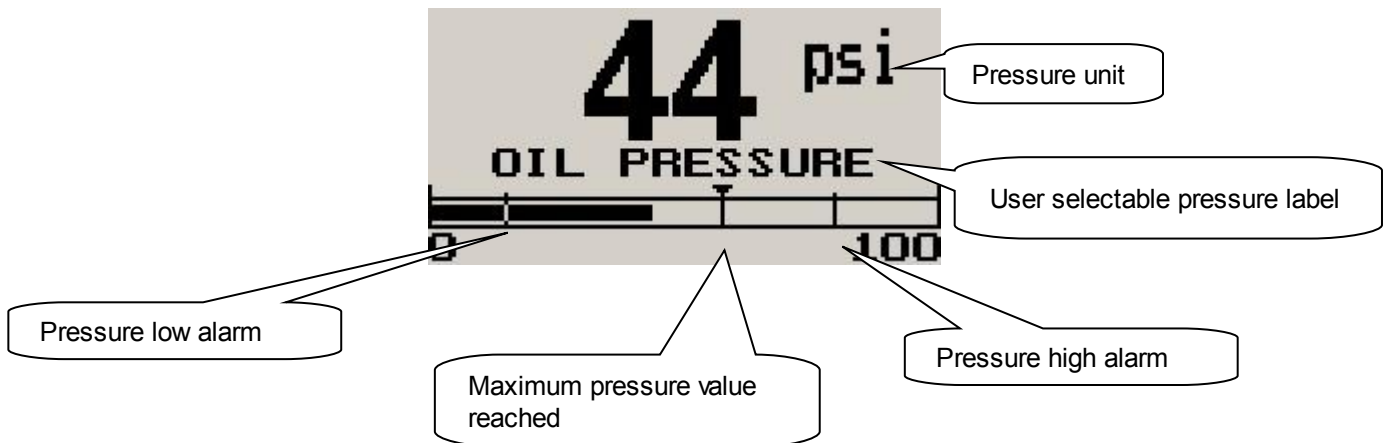

3.1 Permanent maximum values display

This display can be accessed by pressing the F1 key during the normal display mode. Pressing the F1 key again will reset the permanent maximum values to the current temperature and pressure values. Pressing any other key will cause the TP-2 to return to the normal display mode. To avoid false recordings, the maximum values function is only activated 10 seconds after the instrument has powered up.



Note: The permanent maximum values are stored in non-volatile memory and are recalled on power-up.

3.2 Contrast display

This display can be accessed by pressing the F2 key during the normal display mode. This is a quick access key to the same contrast menu as in the menu system.



Use the up and down keys or the rotary control to adjust the display contrast.

4 Menu System

Pressing the rotary control button during the normal display mode will cause the TP-2 to enter the menu system. Use the up/down keys or the rotary control to navigate through the menu system.

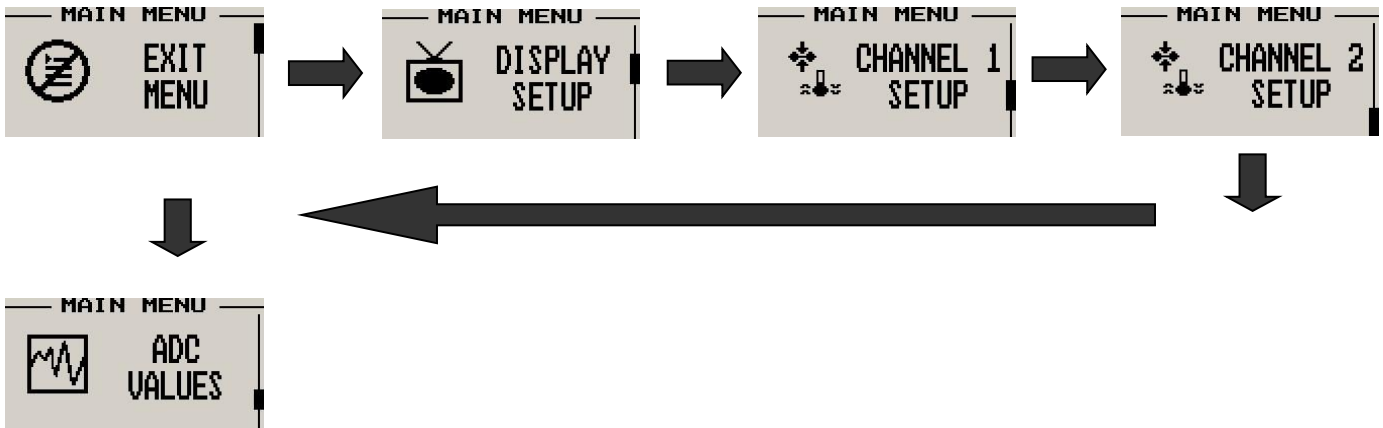

Note: "ADC Values" menu item is only visible when switching the unit on and pressing the rotary control. The text "CALIBRATE" will appear on the intro screen when entering this mode.

4.1 Exit Menu



Pressing the rotary control on this menu item will cause the TP-2 to exit the menu system. All changes made during navigation of the menu system will be saved in non-volatile memory on exiting the menu system. If you remove power before exiting the menu the instrument will not save any changes.

4.2 Display Setup



Move the highlight over this menu item and press the rotary button to return to the main menu.

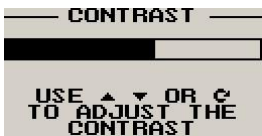

Select this menu option to adjust the display contrast.



Select this menu option to turn the backlight on or off.

```
- DISPLAY SETUP -
*** DONE ***
ADJUST CONTRAST
BACKLIGHT: ON
DISPLAY: SINGLE
BAR: VERTICAL
MODE: AUTO
DISPLAY TIME: 3S
```

If "SINGLE" is selected then only temperature or pressure is shown at one time. If "DUAL" is selected then both temperature and pressure are shown on the same screen.

```
- DISPLAY SETUP -
*** DONE ***
ADJUST CONTRAST
BACKLIGHT: ON
DISPLAY: SINGLE
BAR: VERTICAL
MODE: AUTO
DISPLAY TIME: 3S
```

Select whether you want the temperature and pressure bar to be shown vertically or horizontally.

```
- DISPLAY SETUP -
*** DONE ***
ADJUST CONTRAST
BACKLIGHT: ON
DISPLAY: SINGLE
BAR: VERTICAL
MODE: AUTO
DISPLAY TIME: 3S
```

Select whether you want the single temperature/pressure display to alternate automatically or manually. This display is only shown if display mode is setup to show "SINGLE".

```
- DISPLAY SETUP -
*** DONE ***
ADJUST CONTRAST
BACKLIGHT: ON
DISPLAY: SINGLE
BAR: VERTICAL
MODE: AUTO
DISPLAY TIME: 3S
```

Set the time that the single display modes must be displayed for. This display is only shown if auto is selected for the display mode.

4.3 Channel 1 / Channel 2 Setup

The TP-2 can be setup to display temperature or pressure for each individual input channel.

```
MAIN MENU
CHANNEL 1
SETUP
```

```
MAIN MENU
CHANNEL 2
SETUP
```

Setup is shown for Channel 1, Channel 2 is identical in setup

```
CH 1 SETUP
*** DONE ***
MODE: PRESSURE
TYPE: RESISTIVE
SENDER: UDO
MAX RES: 180Ω
MAX PRESS: 10.0
SENDER DIR: INC
```

Move the highlight over this menu item and press the rotary button to return to the main menu.

```
CH 1 SETUP
*** DONE ***
MODE: PRESSURE
TYPE: RESISTIVE
SENDER: UDO
MAX RES: 180Ω
MAX PRESS: 10.0
SENDER DIR: INC
```

```
CH 1 SETUP
*** DONE ***
MODE: TEMP
SENDER: UDO
LABEL: OIL
UNIT: °C
SPAN: 150°C
TOPSCALE: ON
```

Select what type of sender is connected to the input channel. Select between pressure, temperature or off.

4.3.1 Pressure Setup

```
CH 1 SETUP
*** DONE ***
MODE: PRESSURE
TYPE: RESISTIVE
SENDER: UDO
MAX RES: 180Ω
MAX PRESS: 10.0
SENDER DIR: INC
```

Select if you are using a resistive, 4-20mA or 0-5V output pressure sender.

If the “Resistive” pressure sender is selected

```

CH 1 SETUP
*** DONE ***
MODE: PRESSURE
TYPE: RESISTIVE
SENDER: VDO
MAX RES: 180Ω
MAX PRESS: 10.0
SENDER DIR: INC
    
```

Select what type of resistive pressure sender you are using. Select “VDO” for VDO / resistive senders, “USER” for a custom sender.

```

CH 1 SETUP
*** DONE ***
MODE: PRESSURE
TYPE: RESISTIVE
SENDER: VDO
MAX RES: 180Ω
MAX PRESS: 10.0
SENDER DIR: INC
    
```

Enter the maximum resistance of your pressure sender. Common VDO pressure senders are typically 180 Ohms.

```

CH 1 SETUP
*** DONE ***
MODE: PRESSURE
TYPE: RESISTIVE
SENDER: VDO
MAX RES: 180Ω
MAX PRESS: 10.0
SENDER DIR: INC
    
```

Enter the maximum pressure for your pressure sender. If you are using a VDO 10 bar pressure sender then enter in 10.0, if you are using a VDO 5 bar, then enter in 5.0, if you are using a VDO 2 bar then enter in 2.0. Enter the maximum pressure in the selected unit VDO 10BAR = 145PSI.

```

CH 1 SETUP
*** DONE ***
MODE: PRESSURE
TYPE: RESISTIVE
SENDER: VDO
MAX RES: 180Ω
MAX PRESS: 10.0
SENDER DIR: INC
    
```

Select whether your pressure sender increases resistance with pressure or decreases resistance with pressure. VDO senders normally increase resistance with pressure.

If the “0-5V” pressure sender is selected

```

CH 1 SETUP
*** DONE ***
MODE: PRESSURE
TYPE: 0-5V
SENDER: UMA
MODEL: TIE007
LABEL: OIL
UNIT: BAR
    
```

Select the type of 0-5V sender used. Select “UMA” for UMA senders of “USER” for a custom 0-5V sender.

```

CH 1 SETUP
*** DONE ***
MODE: PRESSURE
TYPE: 0-5V
SENDER: UMA
MODEL: TIE007
LABEL: OIL
UNIT: BAR
    
```

For UMA senders select the UMA model number.

If the “4-20mA” pressure sender is selected

Please note that only 1 4-20mA pressure sender can be interfaced to the TP-2.

```

CH 1 SETUP
*** DONE ***
MODE: PRESSURE
TYPE: 4-20mA
SENDER: VDO
PRES 4mA: 0.0
PRES 20mA: 10.0
LABEL: OIL
    
```

Select the type of 4-20mA sender used. Select “VDO” for VDO senders of “USER” for a custom 4-20mA sender.

```

CH 1 SETUP
*** DONE ***
MODE: PRESSURE
TYPE: 4-20mA
SENDER: VDO
PRES 4mA: 0.0
PRES 20mA: 10.0
LABEL: OIL
    
```

Enter the pressure specified at 4mA output.

```

CH 1 SETUP
*** DONE ***
MODE: PRESSURE
TYPE: 4-20mA
SENDER: VDO
PRES 4mA: 0.0
PRES 20mA: 10.0
LABEL: OIL
    
```

Enter the pressure specified at 20mA output.

If the “User” pressure sender is selected

```

CH 1 SETUP
*** DONE ***
MODE: PRESSURE
TYPE: RESISTIVE
SENDER: USER
CALIBRATE SENDER
LABEL: OIL
UNIT: BAR
    
```

A custom sensor can be interfaced to the TP-2. This sensor can be a resistive, 4-20mA or 0-5V sender.

```

CH 1 SETUP
*** DONE ***
MODE: PRESSURE
TYPE: RESISTIVE
SENDER: USER
CALIBRATE SENDER
LABEL: OIL
UNIT: BAR
    
```

If the sender type is set to “USER”, then use this menu option to calibrate your pressure sender. See section 4.3.3 for more information.

Menu options for all sender types

```

CH 1 SETUP
MODE: PRESSURE
TYPE: RESISTIVE
SENDER: VDO
MAX RES: 180Ω
MAX PRESS: 10.0
SENDER DIR: INC
LABEL: OIL
    
```

Choose one of a selection of labels to suit your pressure input so you can identify it easily.

```

CH 1 SETUP
TYPE: RESISTIVE
SENDER: VDO
MAX RES: 180Ω
MAX PRESS: 10.0
SENDER DIR: INC
LABEL: OIL
UNIT: BAR
    
```

Select whether you want to display the pressure in Bar, PSI or PSI(0.1). The PSI(0.1) is for low range pressure senders e.g. UMA 7PSI.

```

CH 1 SETUP
SENDER: VDO
MAX RES: 180Ω
MAX PRESS: 10.0
SENDER DIR: INC
LABEL: OIL
UNIT: BAR
SPAN: 10.0 BAR
    
```

Set the range of the pressure sender. This is the maximum that the bargraph display will go to.

```

CH 1 SETUP
MAX RES: 180Ω
MAX PRESS: 10.0
SENDER DIR: INC
LABEL: OIL
UNIT: BAR
SPAN: 10.0 BAR
TOPSCALE: OFF
    
```

This allows the user to zoom into the top half of the bar graph resulting in a higher display resolution. This option set to “ON” is recommended.

```

CH 1 SETUP
MAX PRESS: 10.0
SENDER DIR: INC
LABEL: OIL
UNIT: BAR
SPAN: 10.0 BAR
TOPSCALE: OFF
ALARM LOW: ON
    
```

Select whether to use the low pressure alarm.

```

CH 1 SETUP
SENDER DIR: INC
LABEL: OIL
UNIT: BAR
SPAN: 10.0 BAR
TOPSCALE: OFF
ALARM LOW: ON
ALARM LOW: 1.5
    
```

Use this to set the low pressure alarm set-point.

```

CH 1 SETUP
LABEL: OIL
UNIT: BAR
SPAN: 10.0 BAR
TOPSCALE: OFF
ALARM LOW: ON
ALARM LOW: 1.5
ALARM HIGH: ON
    
```

Select whether to use the high pressure alarm.

```

CH 1 SETUP
UNIT: BAR
SPAN: 10.0 BAR
TOPSCALE: OFF
ALARM LOW: ON
ALARM LOW: 1.5
ALARM HIGH: ON
    
```

Use this to set the high pressure alarm set-point.

4.3.2 Temperature Setup

```

CH 1 SETUP
*** DONE ***
MODE: TEMP
SENDER: VDO
LABEL: OIL
UNIT: °C
SPAN: 150°C
TOPSCALE: ON
    
```

Select what type of sender you are using. Select “VDO” a VDO resistive sender, “MGL” for a MGL NTC resistive temperature sender, LM335 for a MGL precision temperature sender or “USER” for a custom sender. The TP-2 has a built in linearization curve for a standard 50°C to 150°C VDO resistive sender as well as for the MGL NTC resistive sender.

If the sender type is set to “User”

```

CH 1 SETUP
*** DONE ***
MODE: TEMP
SENDER: USER
CALIBRATE SENDER
LABEL: OIL
UNIT: °C
SPAN: 150°C
    
```

```

CH 1 SETUP
*** DONE ***
MODE: TEMP
SENDER: USER
CALIBRATE SENDER
LABEL: OIL
UNIT: °C
SPAN: 150°C
    
```

If the sender type is set to “USER”, then use this menu option to calibrate your temperature sender. See section 4.3.3 for more information.

If the sender type is set to “LM335”

```

CH 1 SETUP
*** DONE ***
MODE: TEMP
SENDER: LM335
CALIBRATE SENDER
LABEL: OIL
UNIT: °C
SPAN: 150°C
    
```

If the sender type is set to LM335, then use this menu option to calibrate your LM335 precision temperature sender. If recalibration is required then adjust the value using the up/down keys or the rotary control until the temperature matches the reference ambient temperature. Please note that the LM335 can only be calibrated in degrees Celcius irrespective if the TP-2 is setup to display temperature in Fahrenheit.

Menu options for all sender types

```

CH 1 SETUP
*** DONE ***
MODE: TEMP
SENDER: VDO
LABEL: OIL
UNIT: °C
SPAN: 150°C
TOPSCALE: ON
    
```

Choose one of a selection of labels to suit your temperature input so you can identify it easily.

```

CH 1 SETUP
*** DONE ***
MODE: TEMP
SENDER: VDO
LABEL: °C
UNIT: °C
SPAN: 150°C
TOPSCALE: ON
    
```

Select whether you want the temperature to be displayed in degrees Celcius (°C) or in degrees Fahrenheit (°F).

```

CH 1 SETUP
*** DONE ***
MODE: TEMP
SENDER: VDO
LABEL: OIL
UNIT: °C
SPAN: 150°C
TOPSCALE: ON
    
```

Set the range of the temperature sender. This is the maximum that the bargraph display will go to.

```

CH 1 SETUP
*** DONE ***
MODE: TEMP
SENDER: VDO
LABEL: OIL
UNIT: °C
SPAN: 150°C
TOPSCALE: ON
    
```

This allows the user to zoom into the top half of the bar graph resulting in a higher display resolution. This option set to “ON” is recommended.

```

CH 1 SETUP
MODE: TEMP
SENDER: VDO
LABEL: OIL
UNIT: °C
SPAN: 150°C
TOPSCALE: ON
ALARM LOW: ON
    
```

Select whether to use the low temperature alarm.

```

CH 1 SETUP
SENDER: VDO
LABEL: OIL
UNIT: °C
SPAN: 150°C
TOPSCALE: ON
ALARM LOW: ON
ALARM HIGH: 70
    
```

Use this to set the low temperature alarm set-point.

```

CH 1 SETUP
UNIT: °C
SPAN: 150°C
TOPSCALE: ON
ALARM LOW: ON
ALARM HIGH: ON
    
```

Select whether to use the high temperature alarm.

```

CH 1 SETUP
UNIT: °C
SPAN: 150°C
TOPSCALE: ON
ALARM LOW: ON
ALARM LOW: 70
ALARM HIGH: ON
ALARM HIGH: 185
    
```

Use this to set the high temperature alarm set-point.

4.3.3 Calibrating the user defined pressure and temperature sender

```

PRESSURE: 379
*** DUNE ***
POINTS: 6
DISPLAY 1: 0.0
ADC 1: 0021
DISPLAY 2: 2.0
ADC 2: 0131
DISPLAY 3: 4.0
    
```

1. Enter the number of points that you want to calibrate.
2. Enter the display reading that you want to show when the sender is at that actual display reading.
3. Enter the ADC (analog to digital converter) reading that corresponds to this display reading. The ADC reading is shown at the top of the calibration menu if you are applying the actual stimulus from the temperature or pressure sender. You can also manually enter this value if the ADC value is known or pre-calculated.
4. Continue entering display and ADC values until all the points have been entered.
5. Verify the above calibration by checking the temperature/pressure display versus the actual applied sender stimulus.

```

TEMP: 430
*** DUNE ***
POINTS: 10
DISPLAY 1: 010
ADC 1: 2250
DISPLAY 2: 050
ADC 2: 0728
DISPLAY 3: 066
    
```

4.4 ADC Values

```

MAIN MENU
[Waveform Icon] ADC
VALUES
    
```

Note: This menu item is for technical personnel only, and is not displayed during the normal operation of the instrument. Please see section 4 above on how to access this menu item.

```

ADC VALUES
*** DUNE ***
CH 1: 405
CH 2: 683
    
```

This menu displays the ADC values that have been read from channel 1 and channel 2.

5 Loading Factory default settings

Pressing and holding the F1 and F2 keys simultaneously on power up will cause the TP-2 to load preprogrammed factory default settings. The following screen will be displayed:

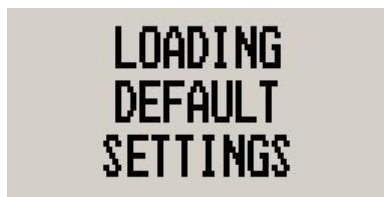

6 Operating the alarms

If the alarm is activated, the corresponding item on the display will flash. At the same time the externally available alarm switch will close. The switch will remain closed until any button is pressed to acknowledge the alarm or until the condition(s) that activated the alarm no longer exist. The alarm output can be used to switch an external alarm indicator. The external alarm switch is an open collector transistor switch to ground with a maximum rating of 0.5A DC. It is possible to wire the alarm contacts of several Stratomaster instruments in parallel should this be desired. To avoid false activation of the alarms, the alarm function is only active 10 seconds after the instrument has powered up.

7 Cleaning

The unit should not be cleaned with any abrasive substances. The screen is very sensitive to certain cleaning materials and should only be cleaned using a clean, damp cloth.

Warning: The TP-2 is not waterproof. Serious damage could occur if the unit is exposed to water and/or spray jets.

8 TP-2 Specifications

| | |
|-------------------------------------|---|
| Operating Temperature Range | -10°C to 50°C (14°F to 122°F) |
| Storage Temperature Range | -20°C to 80°C (-4°F to 176°F) |
| Humidity | <85% non-condensing |
| Power Supply | 8 to 30Vdc SMPS (switch mode power supply) with built in 33V over voltage and reverse voltage protection |
| Current Consumption | Approx. 38mA @ 13.8V (backlight on) 12mA @13.8V (backlight off) |
| Display | 128x64 graphic LCD display. Contrast and backlight is user configurable, green/yellow backlight |
| ADC | 12bit over sampled successive approximation |
| Dimensions | see Velocity series dimensional drawing |
| Enclosure | 3 1/8" ABS, black in color, front or rear mounting |
| Weight | Approx. 174 grams |
| Alarm contact current rating | Open collector transistor switch to ground. Maximum rating 0.5A DC |
| Non-volatile memory storage | 100000 write cycles |
| Temperature sensors | <p>VDO Resistive Senders: Standard 50°C to 150°C resistive temperature sender.</p> <p>MGL NTC Resistive Sender: Echlin TS920SA automotive temperature sender</p> <p>MGL Precision LM335 semiconductor: Based on National Semiconductor LM335 temperature sensor</p> <p>User defined senders: The TP-2 has a user sender calibration feature that can be customized for senders not listed above</p> |
| Pressure sensors | <p>VDO Resistive Sender: Standard VDO resistive pressure senders. VDO pressure senders used to measure fuel pressure require the fuel isolation kit available from VDO.</p> <p>Rotax 4-20mA Sender: The TP-2 supports the 4-20mA pressure sender as used in Rotax 912/914 engines.</p> <p>The 4-20mA pressure sender uses pin 8 (Yellow) on the DB9 connector.</p> <p>0-5V Output Pressure Senders: e.g. UMA that outputs a 0-5V signal.</p> <p>The TP-2 has built in linearisation curves for the UMA T1EU07, T1EU35, T1EU70A , T1EU70, T1EU100 and T1EU150</p> <p>User defined senders: TP-2 has a user sender calibration feature that can be customized for senders not listed above.</p> |

9 Installation

Temperature senders

Four types of temperature senders can be fitted:

VDO Resistive senders: A standard 50°C to 150°C VDO resistive automotive sender can be used.

MGL NTC resistive senders: A suitable sender with the same thread used by Rotax can be obtained from MGL Avionics (manufacturer Echlin).

Most NTC senders require a single wire connected as shown. The sender is grounded via the engine block. The ground terminal of the gauge input should be connected to the engine block. Some NTC senders have two wires. In this case it is not required that the sender housing itself is connected to the engine block. Wire the second wire to the reference ground terminal.

MGL Precision senders (National Semiconductors LM335): These are senders containing a semiconductor temperature measurement device. They can be used for water or oil temperature. These senders are available in two types: an encapsulated version with a brass housing suitable for Rotax thread; a second uncommitted version contains only the sensor itself. This can be conveniently mounted inside an existing sender housing after you remove the original insides of the sender. This is intended to give you a solution for unusual or difficult to obtain senders.

Connect the Black wire to ground, the Red or green wire to the channel input.

User defined senders: The TP-2 has a user sender calibration feature that can be customized for senders not listed above.

Connect the temperature sender to the orange (Pin 2) or green (Pin 3) wire on the DB9 connector

Pressure senders

Four types of pressure senders can be fitted

VDO Resistive senders: Most pressure senders used for engines are resistive types. These tend to have a very low resistance at low pressures and a high resistance at their maximum pressure output. The resistance is approximately linear with pressure. The TP-2 supports both increased resistance with pressure as well as decrease resistance with pressure types. The TP-2 allows you to choose the pressure sender type as described in the relevant section of this manual. Most automotive types have resistance ranges from 10 to 400 ohms. For example: the oil pressure sender as installed in a Rotax 912/914 engine has approx. 10 Ohms at 0 Bar and 180 Ohms at 10 bars.

Connect your VDO/resistive sender to the orange (Pin 2) or green (Pin 3) wire on the DB9 connector.

4-20mA Pressure Senders: The TP-2 supports the 4-20mA pressure sender as used in Rotax 912/914 engines

Connect your VDO 4-20mA senders white wire to the yellow wire on the DB9 connector (Pin 8).

0-5V output senders: e.g. UMA that can be used with the TP-2 are those types that have their maximum output voltage of 5V at their maximum pressure output. The TP-2 has built in linearisation curves for the UMA T1EU07, T1EU35, T1EU70A, T1EU70, T1EU100 and T1EU150

Connect your UMA/Voltage output sender to the orange (Pin 2) or green (Pin 3) wire on the DB9 connector.

User defined senders: The TP-2 has a user sender calibration feature that can be customized for Resistive, 4-20mA as well as Voltage output senders.

Senders that are grounded in the engine block

Single wire senders require that their mounting arrangement (thread) has a very good electrical contact with the engine block. Avoid the use of any sealant or tapes as these may cause a bad electrical connection. Further to this it is very important that the engine block has a good electrical connection to the negative supply terminal of the TP-2. Any voltage drop caused by other equipment on the ground wire will cause incorrect readings. The best way to ensure a good connection is to wire a single connection between the TP-2 ground terminal (any of these terminals) and the engine block. Do not wire this anywhere else and do not allow any other equipment to use this wire as a current return path.

9.1 Connection Diagram

The use of an external 1A fuse is recommended. Connect the supply terminals to your aircrafts power supply. The TP-2 can be used on both 12V and 24V without the use of any pre-regulators. Ensure that the supply voltage will not drop below 8V during operation as this may result in incorrect voltage and or current readings.

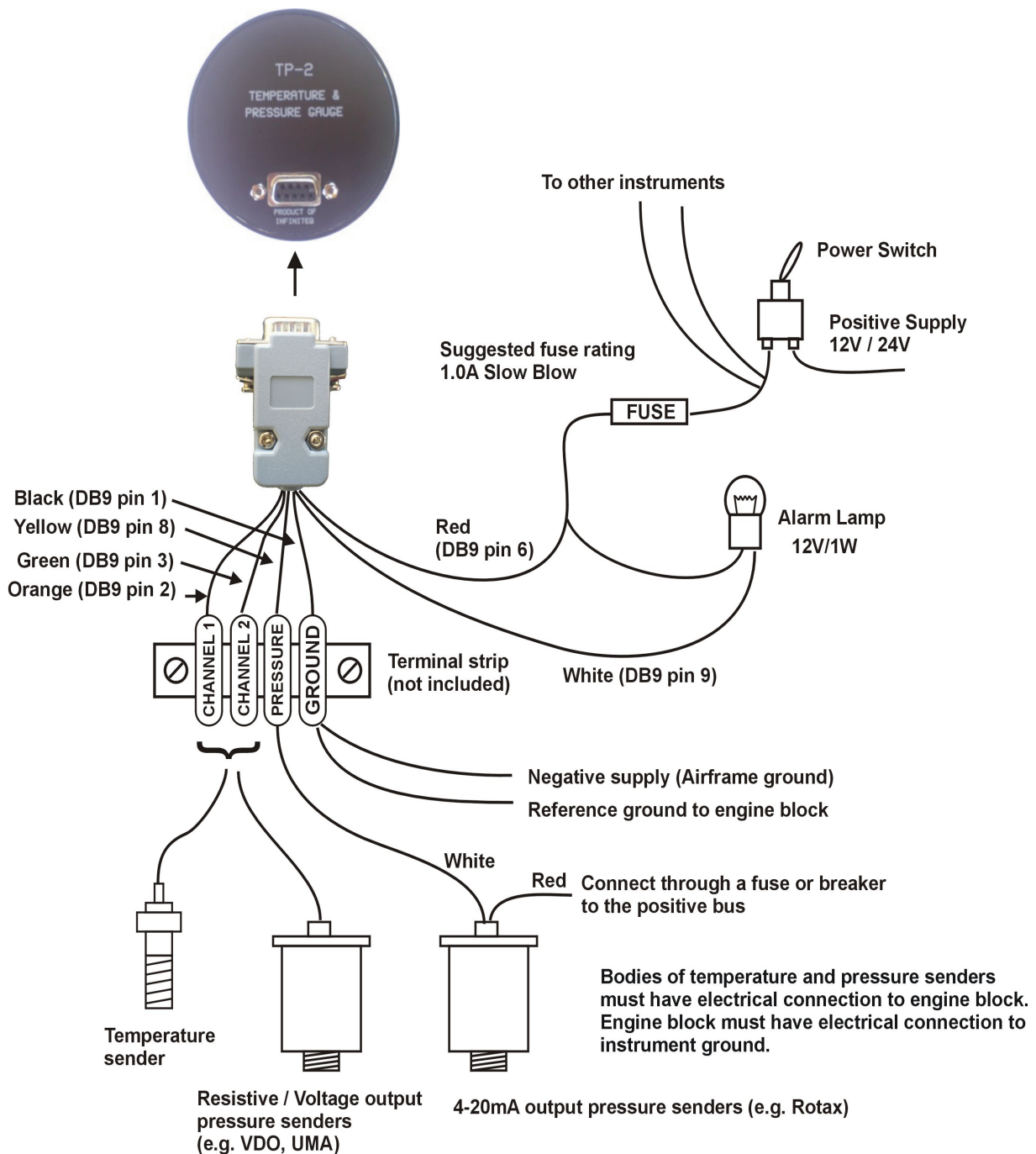

9.2 UMA Voltage output pressure sender (0 to 5V output)



Pinout:

- White/Red: +12V
- White: Signal
- White/Blue: Ground
- Shield: Ground

9.3 VDO 4-20mA Pressure sender

DIMENSIONS for reference only mm (in)

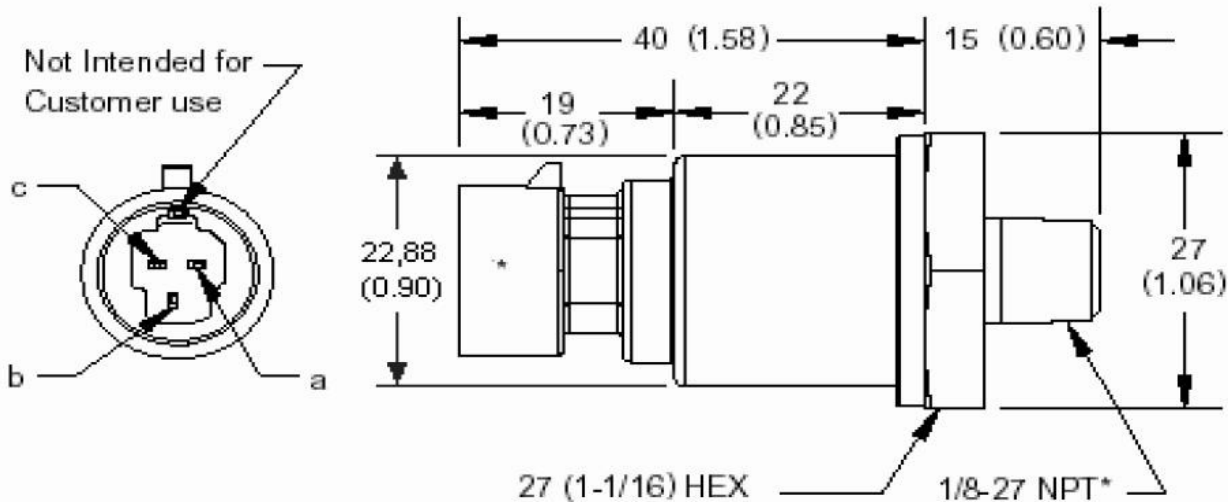

The sensor cable is approximately 3m long and has 3 leads. The black lead is not to be connected and has no function. The Red lead from the sensor has to be connected to the positive bus via a fuse or circuit breaker . The white lead (Output signal) has to be connected directly to the TP-2 Yellow wire (Pin 8).

9.4 TP-2 DB9 Cable connections

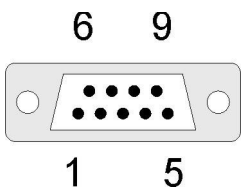

| DB 9 Pin | Color | Function |
|----------|--------|---|
| 1 | Black | Ground |
| 2 | Orange | Channel 1 input (Pressure and Temperature sender input, resistive and 0-5V) |
| 3 | Green | Channel 2 input (Pressure and Temperature sender input, resistive and 0-5V input) |
| 4 | NC | Airtalk communication (Not connected) Used for firmware upgrading |
| 6 | Red | 8-30Vdc power |
| 8 | Yellow | Pressure Sender input (4-20mA) |
| 9 | White | Alarm Output |

10 Warranty

This product carries a warranty for a period of one year from date of purchase against faulty workmanship or defective materials, provided there is no evidence that the unit has been mishandled or misused. Warranty is limited to the replacement of faulty components and includes the cost of labour. Shipping costs are for the account of the purchaser.

Note: Product warranty excludes damages caused by unprotected, unsuitable or incorrectly wired electrical supplies and or sensors, and damage caused by inductive loads.

11 Disclaimer

Operation of this instrument is the sole responsibility of the purchaser of the unit. The user must make themselves familiar with the operation of this instrument and the effect of any possible failure or malfunction.

This instrument is not certified by the FAA. Fitting of this instrument to certified aircraft is subject to the rules and conditions pertaining to such in your country. Please check with your local aviation authorities if in doubt. This instrument is intended for ultralight, microlight, homebuilt, experimental and light sport aircraft. Operation of this instrument is the sole responsibility of the pilot in command (PIC) of the aircraft. This person must be proficient and carry a valid and relevant pilot's license. This person has to make themselves familiar with the operation of this instrument and the effect of any possible failure or malfunction. Under no circumstances does the manufacturer condone usage of this instrument for IFR flights.

The manufacturer reserves the right to alter any specification without notice.

Other instruments in the *Stratomaster Velocity* series

| | |
|-----------------|---|
| ALT-3 | Encoding aviation altimeter and Vertical speed indicator (VSI) |
| ALT-4 | Encoding aviation altimeter with Serial RS232 & Parallel Gillham code output |
| ASI-3 | Airspeed indicator (ASI) with automatic flight log |
| ASX-2 | Encoding aviation altimeter and Airspeed indicator (ASI) |
| AV-2 | Artificial horizon and magnetic compass indicator |
| E-1 | Universal engine monitor |
| FLIGHT-2 | Primary Flight instrument |
| FF-3 | Fuel Computer (single or dual fuel tanks) |
| GF-2 | +/-10G tilt compensated dual range G-force meter |
| MAP-2 | Manifold pressure and RPM Indicator |
| ROTOR-1 | Dual Rotor / Engine tachometer |
| RTC-1 | Aviation real time clock (RTC), outside air temperature (OAT) and Voltage display |
| RV-3 | Universal engine / Rotor RPM Indicator |
| TC-2 | 4-Channel thermocouple (EGT/CHT) indicator |
| TC-3 | 12-Channel thermocouple (EGT/CHT) indicator |
| TP-2 | Universal temperature and pressure gauge |