

# FLIGHT-2

## Primary Flight Instrument

Operating Manual – English 1.00



## Introduction

The Flight-2 is a compact, multifunction complete primary flight system intended as a main flight instrument on smaller aircraft or as a backup / secondary flight instrument in larger aircraft. This 3 1/8" instrument provides many functions from an altimeter, airspeed indicator, fuel level and flow, engine RPM and many secondary functions, including an automatic flight log. The Flight-2's light weight, small size and high level of functionality makes it an excellent choice for many applications.

The Flight-2 makes an ideal companion to the Velocity E-1 universal engine monitor for a compact, low cost yet highly functional and complete cockpit solution.

## 1 Features

- Altimeter (-700ft (-213m) to 30 000ft (9144m)). Altitude can be displayed in feet or meters. Local pressure can be set in mbar or in "Hg.
- Airspeed indicator (16mph to 250mph).
- Altitude compensated digital VSI indicator (+/-20 ft/min to +/-10 000 ft/min) and a logarithmic analog VSI indicator (+-2000 ft/min range). VSI can be displayed in ft/min or m/s.
- Automatic flight duration timer
- Fuel flow (optional fuel flow sender). Fuel flow can be displayed in liters or Gallons.
- Fuel level calculated from fuel flow or from a fuel level sender
- Multi point fuel level sender calibration to compensate for odd shaped tanks and nonlinear fuel level senders
- Current range estimate (range at current speed and fuel burn). Can be displayed in statute/nautical mile or in kilometers
- Fuel bingo estimate (time until tank empty)
- Universal RPM counter (0 to 20000RPM)
- Real Time Clock (RTC) for local time and flight log use
- Settable Hobbs meter (password protected)
- Programmable Maintenance timer for scheduled routine engine maintenance
- OAT (Outside air temperature) display using an external sensor
- Supply Voltage display
- Density altimeter
- Barometer (actual local pressure)
- True airspeed (TAS display)
- Fuel range based on TAS, IAS or GPS-NMEA input
- Fuel endurance based on TAS, IAS or GPS-NMEA input
- Stopwatch
- Glide and climb ratio indicator
- Alarm on low/high RPM, low/high airspeed, low/high supply voltage and low fuel level
- Records maximum values reached in permanent memory
- Includes a 24 entry automatic flight log
- Standard 3 1/8" aircraft enclosure (can be front or rear mounted)
- Rotary control plus 2 independent buttons for easy menu navigation and user input
- External alarm output as well as a red LED illuminates when the alarm has been activated
- Large backlit graphic LCD with adjustable contrast

- Wide input supply voltage range of 8 to 30V DC with built in voltage reversal and over voltage protection for harsh electrical environments
- Light weight design
- 1 year limited warranty

## 2 FLIGHT-2 Layout



**LED Alarm:**  
The red LED will illuminate if any of the alarm conditions have been exceeded

**Pressure Ports:**  
Pressure ports connect to static and pitot tubes

**Harness:**  
Harness connects to power and signals

**Up/F1 Button:**  
Up button in menu system  
Auxiliary flight information page toggle in normal mode

**Down/F2 Button:**  
Down button in menu system  
Various functions in normal mode. See Auxiliary flight information displays below.

**Rotary Control (Up/Down) & Enter Button:**  
Press the rotary control during normal mode to access the menu system. Rotate anti/clockwise for up/down menu scrolling. During normal mode rotating the rotary control will adjust the local pressure setting. Local pressure can be set in either mB or in "Hg.

## 3 Main Display

The bottom left of the main display is arranged in four auxiliary flight information displays.

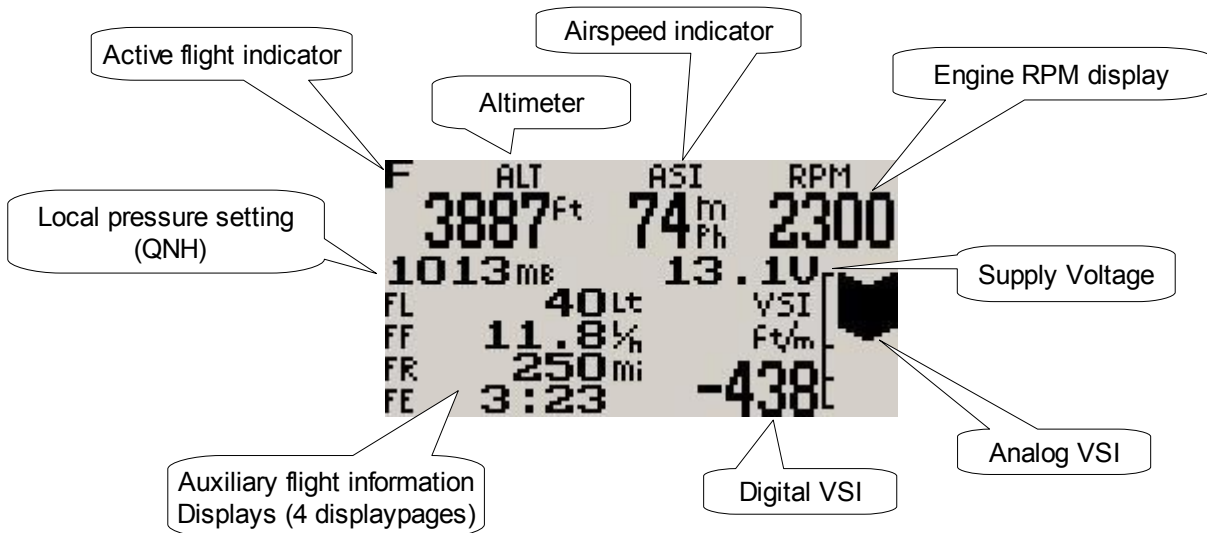

### 3.1 Auxiliary flight information display 1

This page displays all the fuel related information. Fuel level, flow, range and endurance is shown.

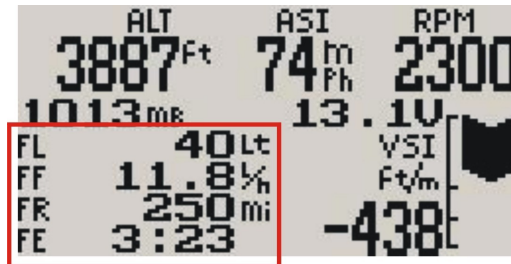

#### 3.1.1 Enter starting level of the fuel tank



Press the F2 key during the auxiliary flight information display 1 to manually enter your current fuel level after fueling or defueling your aircraft. This function is only available if you have selected calculated fuel level. Press the F2 key again as a “quick fill button” to the full level.

**Note:** It is good airmanship to take into account a “silent” fuel reserve. For example, if you have a 50 liter tank and you fill it, enter 40 or 45 liters as your available fuel.

### 3.2 Auxiliary flight information display 2

This page displays the RTC, flight time and stopwatch.



#### Real Time Clock

Time of day is often displayed as UTC or Greenwich time as it required by ATC.

#### Flight time

The flight time is automatically reset to zero when a new flight is started.

#### Stop Watch

Press the F2 key to start/stop the stopwatch. Hold the F2 key for 3 seconds to reset the stop watch to zero. The stopwatch icon will flash when the stopwatch is running.

### 3.3 Auxiliary flight information display 3

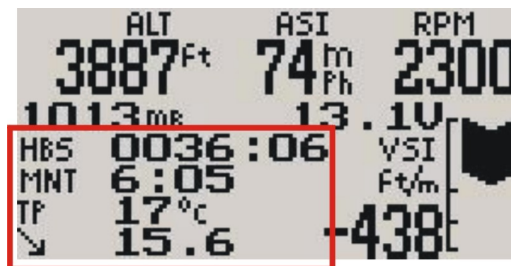

#### Hobbs Timer

The Flight-2 contains a password protected hobbs timer. The Hobbs time can be set to the current known engine time in the menu system.

#### Maintenance Timer

This timer is set in engine hours and it will count down to zero when the engine RPM is greater then the Hobbs RPM limit. A good use for this function is to set the hours until your next spark plug change or engine inspection. See the maintenance timer section below for more details.

#### OAT

Outside air temperature can be measured using the external temperature probe.

#### Glide Ratio

Glide ratio can be measured up to 1:99. Glide ratio is measured as a ratio between forward movement of the aircraft vs. vertical sink rate. Please note that the forward movement of the aircraft is not synonymous with horizontal forward movement relative to the earth surface but is a function of airspeed.

#### Climb Ratio

Climb ratio can be measured up to 1:99. Climb ratio is measured as a ratio between forward movement of the aircraft vs. vertical climb rate. Please note that the forward movement of the aircraft is not synonymous with horizontal forward movement relative to the earth surface but is a function of airspeed.

### 3.3.1 Start/Stop Flight Display



Press the F2 key during the auxiliary flight information display 3 to manually start/stop a flight. This key is only active if the FLIGHT-2 is setup to select the manual flight option under the "FLIGHT LOG" setup menu.

### 3.4 Auxiliary flight information display 4

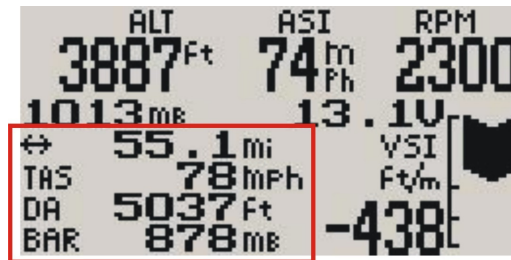

#### Distance through the air trip counter

Air distance can be displayed either in kilometers, miles or nautical miles.

Air distance is calculated taking in to account true airspeed and time since take-off. The FLIGHT-2 can be setup to either automatically reset air distance to zero at the beginning of a flight or you can manually decide when you want to reset air distance to zero.

#### True Airspeed (TAS)

TAS is used for most internal calculations where air distance is of importance.

What is TAS and how is it calculated ?

TAS is indicated airspeed (ASI) compensated for altitude and temperature. Often pilots ignore the effect of temperature and only take altitude into account when converting ASI to TAS. For practical purposes this is quite accurate and gives a good reflection on your true airspeed. Keeping in mind that ASI measurement is subject to errors caused by airflow around your aircraft, there seems little point in taking this calculation to absolute resolution.

Again, we have decided to use a formula often used by pilots. This way the instrument reading will agree with what pilots are used to.

Based on Worthingtons 13th edition page 349:

Add 1.75% of IAS per 1000 ft (304.9 m) increase in altitude above sea level.

We assume here that IAS = RAS (rectified air speed).

#### Density Altitude

Density altitude is a perceived altitude that pertains to your current altitude and temperature (and to a lesser extent on your current moisture content of the air). Density altitude is relevant for performance calculations of your aircraft. Density altitude affects the performance of your engine, propeller and airfoils. The most noticeable affects of density altitude are length of take-off and landing runs and the ability of your aircraft to carry weight. There are several methods to calculate density altitude, all result in readings that are very close to each other. We decided to implement a popular formula that is often used by pilots to calculate density altitude at their location.

Da = Density altitude

Pa = Pressure altitude

T = ambient temperature in degrees C

$$Da = Pa + 118.6 * (T + 0.85)$$

#### Barometer

Ambient pressure can be displayed in either millibar or Inches of Mercury (Inch/Hg). The setup for QNH will determine which.

### 3.4.1 Reset Air Distance Trip Counter Display

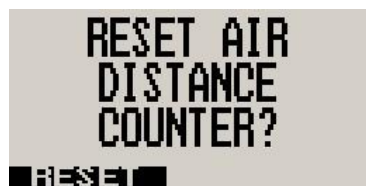

This display can be accessed by pressing the F2 key during the auxiliary flight information display 4. Pressing the F1 key will reset the air distance trip counter to zero. Pressing any other key will cause the FLIGHT-2 to resume to the normal display mode. The air distance trip counter can still be reset manually even if the pilot selects the automatic resetting of the air distance trip counter.

**Note:** The air distance trip counter measures distance flown through the air. This is not the same as distance flown over the ground unless you are flying at sea level at zero wind speed. The air distance shown is subject to under reading at altitude due to decreased air density.

## 4 Maintenance Timer

The purpose of this function is to assist you in determining remaining hours until maintenance will be required. It is not intended as a replacement for the aircraft's maintenance log. It is therefore important that the aircraft's maintenance log be maintained in the normal manner. You should further use your own discretion in performing maintenance earlier than indicated should any aircraft performance problems arise.

A maximum of 999 hours can be entered as a maintenance interval. The FLIGHT-2 will deduct actual engine running time from the maintenance interval hours as set and will display the reminder message on startup when zero hours are remaining. The reminder message will automatically disappear after 5 seconds or if the pilot presses any key. Engine running time for the purpose of the maintenance timer is defined as the run time where the engine RPM is greater than the preset RPM for the Hobbs meter.

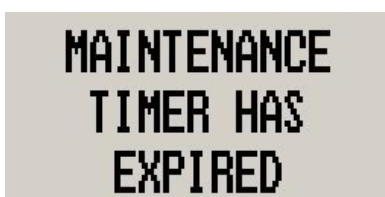

## 5 Menu System

Pressing the rotary control button during the normal display mode will cause the FLIGHT-2 to enter the menu system. Use the up/down keys or the rotary control to navigate through the menu system.

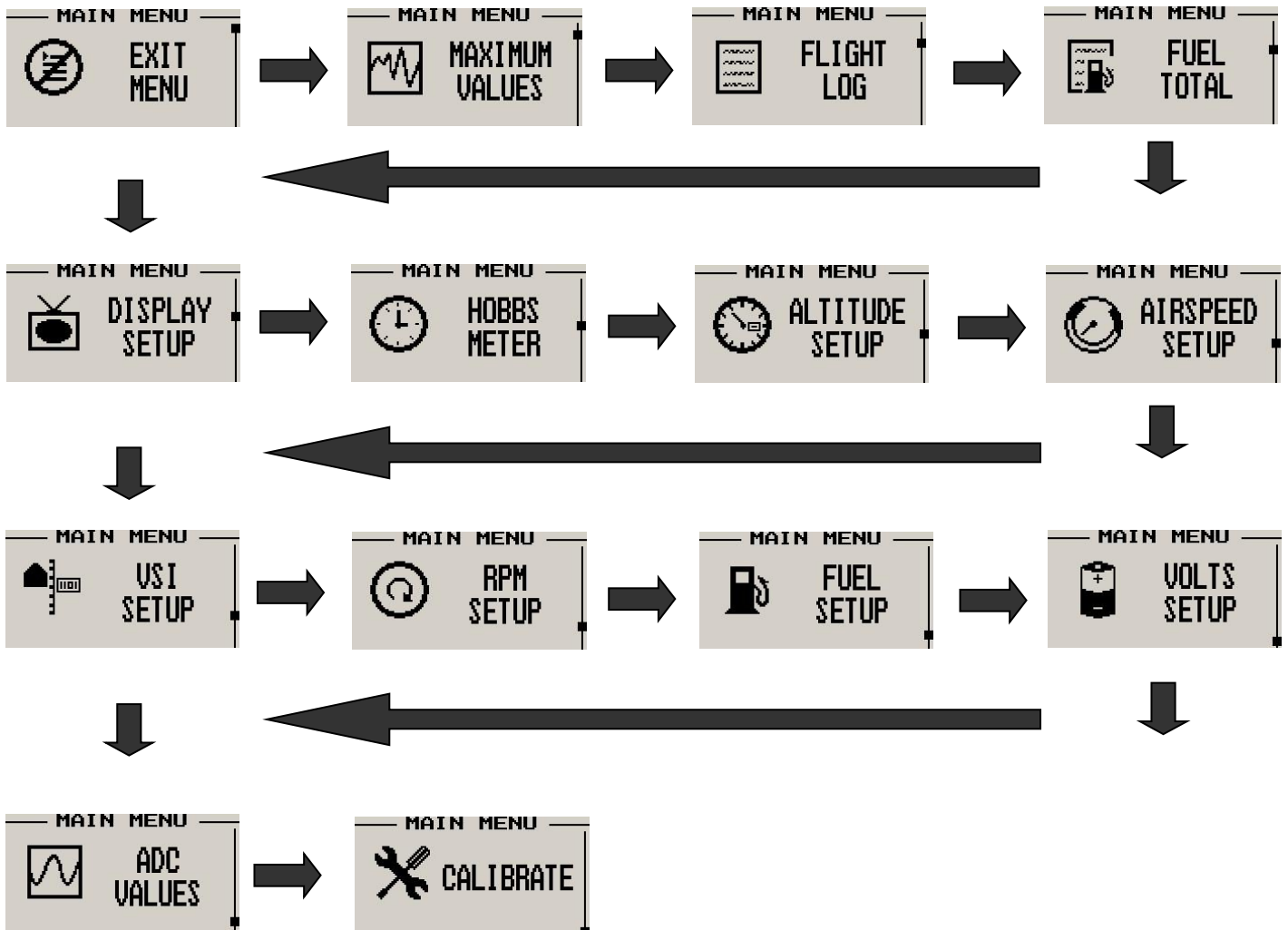

### 5.1 Exit Menu



Pressing the rotary control on this menu item will cause the FLIGHT-2 to exit the menu system. All changes made during navigation of the menu system will be saved in non-volatile memory on exiting the menu system. If you remove power before exiting the menu the instrument will not save any changes.

### 5.2 Maximum Values



To avoid false recordings, the maximum values function is only activated 10 seconds after the instrument has powered up.

```

MAX VALUES
*** DONE ***
RESET VALUES
ALT: 3887 ft
ASI: 114 mph
RPM: 4600
VOLTS: 13.6V
OAT: 3°C 34°C
    
```

Move the highlight over the “DONE” menu item and press the rotary button to return to the main menu.

```

MAX VALUES
*** DONE ***
RESET VALUES
ALT: 3887 ft
ASI: 114 mph
RPM: 4600
VOLTS: 13.6V
OAT: 3°C 34°C
    
```

Move the highlight over this menu item and press the rotary button to reset the maximum values to the current values.

### 5.3 Flight Log

```

MAIN MENU
FLIGHT LOG
    
```

The FLIGHT-2 uses the following algorithm to determine if a flight is in progress (Detect Mode): If airspeed is greater than the preset flight take off airspeed for a duration of 60 seconds or more, a flight is started with a logbook entry. The flight ends if airspeed falls below the preset flight take-off airspeed for 30 seconds. During a flight the logbook cannot be viewed.

The above algorithm ensures that touch-and-goes will not result in the end of a flight and a logbook entry. Should the instrument be switched off during a flight, this will end the flight and the log will reflect the time until the instrument was switched off. Should the instrument be switched on again during a flight, a new flight will start for logging purposes.

```

FLIGHT LOG
*** DONE ***
VIEW LOG
ERASE LOG
HOUR FRACT: MIN
FLIGHT: DETECT
T/O AIRSPD: 30
    
```

Move the highlight over the “DONE” menu item and press the rotary button to return to the main menu

```

FLIGHT LOG
*** DONE ***
VIEW LOG
ERASE LOG
HOUR FRACT: MIN
FLIGHT: DETECT
T/O AIRSPD: 30
    
```

```

FLIGHT LOG
*** DONE ***
1: 00:00
2: 00:00
3: 00:00
4: 00:00
5: 00:00
6: 00:00
    
```

Select this function to view the flight log. The flight log contains the duration of each of the last 24 logged flights. Duration is displayed in hours and minutes. Use the up/down keys or the rotary control to navigate through the log.

**Note:** You cannot select this function while a flight is in progress.

```

FLIGHT LOG
*** DONE ***
VIEW LOG
ERASE LOG
HOUR FRACT: MIN
FLIGHT: DETECT
T/O AIRSPD: 30
    
```

```

? ERASE
FLIGHT LOG
ERASE
    
```

Pressing the F1 key will erase all the flight log entries

```

FLIGHT LOG
*** DONE ***
VIEW LOG
ERASE LOG
HOUR FRACT: MIN
FLIGHT: DETECT
T/O AIRSPD: 30
    
```

Select if you would like the hour to be displayed in decimal fractions (0-99) or minutes (0-59). This setting influences the current flight time display and the flight log.

```

FLIGHT LOG
*** DONE ***
VIEW LOG
ERASE LOG
HOUR FRACT: MIN
FLIGHT: DETECT
T/O AIRSPD: 30
    
```

Select whether you want the FLIGHT-2 to automatically detect a flight or whether the pilot must press the F2 key to start/stop a flight.

```

FLIGHT LOG
*** DONE ***
VIEW LOG
ERASE LOG
HOUR FRACT: MIN
FLIGHT: DETECT
T/O AIRSPD: 30
    
```

This menu option is only shown if the “detect” flight mode is selected. Enter the airspeed that you want to start a flight log.



### 5.4 Fuel Total



This totalizers the amount of fuel burn since the last time the accumulator was reset to zero.



Move the highlight over the "DONE" menu item and press the rotary control to return to the main menu.



Select this menu option to reset the fuel totalizer to zero.

### 5.5 Display Setup



Move the highlight over the "DONE" menu item and press the rotary button to return to the main menu



Select this menu option to adjust the display contrast



Select this menu option to turn the backlight on or off



Select this option to set the date and time



Select whether you want the OAT to be displayed in degrees Fahrenheit (°F) or in degrees Celcius (°C)

## 5.6 Hobbs Meter



Move the highlight over the “DONE” menu option and press the rotary button to return to the main menu.



Enter the RPM limit in which the Hobbs meter/Maintenance timer must start counting.

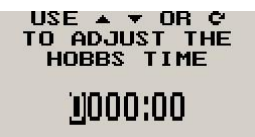
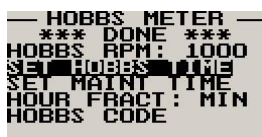

This function allows you to set the engine Hobbs meter to any value. Typically, you would use this function to set the Hobbs meter to the current known engine time. Use the up/down or the rotary control to change the value. Press the rotary control to accept and exit the menu option. If the Hobbs code is set to another value beside zero, then the pilot will be prompted to enter the Hobbs access code before allowing him to change the Hobbs time. This feature is useful for charted and flying school planes.

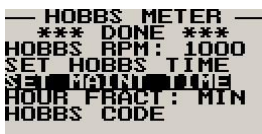

This function allows you to set an engine maintenance timer. This timer is set in engine hours and it will count down to zero when the engine RPM is greater then the Hobbs RPM limit. A good use for this function is to set the hours until your next spark plug change or engine inspection. Use the up/down or the rotary control to change the value. Press the rotary control to accept and exit the menu option.



Select if you would like the hour to be displayed in decimal fractions (0-99) or minutes (0-59). This setting influences the current flight time display and the flight log.



This menu option allows you to change the Hobbs access code. You will first be prompted to enter the current code followed by entering in a new code followed by re-entering the new code. If the new code and the re-entered code is the same, then the Hobbs access code will be changed. **Default code is 0000.**



## 5.7 Altitude Setup



All altitude related parameters can be setup here.

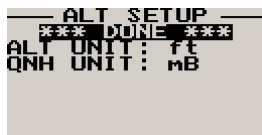

Move the highlight over the “DONE” menu item and press the rotary button to return to the main menu.

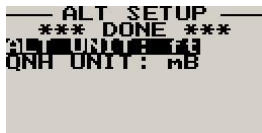

Select if you want your altitude readout in feet (ft) or meters (m).

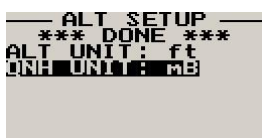

Select if you want your local pressure readout in millibars (mB) or inches of mercury (“Hg).

## 5.8 Airspeed Setup



All the airspeed parameters can be setup here



Move the highlight over this menu option and press the rotary button to return to the main menu

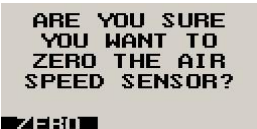

This setup allows your instrument to measure the zero airspeed reading of the airspeed sensor and set a calibration value internally for this. This is equivalent to some mechanical airspeed indicators that have an adjustment to set the needle to zero when the aircraft is not moving. You would use this function occasionally if you see an airspeed reading when the aircraft is at rest. This may be caused by aging of the built in pressure sensor or related electronics. When this function is performed make sure that there is no air flow into the pitot tube as this would result in an incorrect internal calibration.

Pressing the F1 key will zero the airspeed sensor.



Enter the low airspeed set-point for when the alarm must activate. Any speed below this value will activate the alarm.



Select whether you want the low air speed alarm to be turned on or off. The low airspeed alarm is only activated once a flight has started.

```

--- ASI SETUP ---
*** DONE ***
ZERO ASI SENSOR
ASI DISP: IAS
LOW ALARM: 30
LOW ALM: ON
HIGH ALARM: 80
HIGH ALM: ON
    
```

Enter the high airspeed set-point for when the alarm must activate. Any speed above this value will activate the alarm.

```

--- ASI SETUP ---
*** DONE ***
ZERO ASI SENSOR
ASI DISP: IAS
LOW ALARM: 30
LOW ALM: ON
HIGH ALARM: 80
HIGH ALM: ON
    
```

Select whether you want the high air speed alarm to be turned on or off.

```

--- ASI SETUP ---
ZERO ASI SENSOR
ASI DISP: IAS
LOW ALARM: 30
LOW ALM: ON
HIGH ALARM: 80
HIGH ALM: ON
ASI UNIT: MPH
    
```

Select your preferred units. You can select statute miles, kilometers or nautical miles. According to this selection your airspeed will be indicated in mph, km/h or knots.

```

--- ASI SETUP ---
ASI DISP: IAS
LOW ALARM: 30
LOW ALM: ON
HIGH ALARM: 80
HIGH ALM: ON
ASI UNIT: MPH
ASI FILT: FAST
    
```

This function can be used to select the signal filter time constant. Selections are “fast” or “slow”. This selection influences the rate at which your ASI can change its reading. If you have an installation that suffers from strong turbulence at the pitot tube, select “slow”. If you have a very clean airflow in front of the pilot tube you can select “fast” which will give you a faster response to airspeed changes.

```

--- ASI SETUP ---
LOW ALARM: 30
LOW ALM: ON
HIGH ALARM: 80
HIGH ALM: ON
ASI UNIT: MPH
ASI FILT: FAST
DIS ZERO: MAN
    
```

Select if you want the air-distance counter to reset automatically at the start of a flight or if you want to reset it manually only.  
**Note:** You can reset the air distance counter at any time regardless of this setting.

## 5.9 VSI (Vertical Speed Indicator) Setup

```

MAIN MENU
VSI
SETUP
    
```

All VSI related parameters can be setup here.

```

--- VSI SETUP ---
*** DONE ***
ZERO VSI
VSI UNIT: ft/m
VSI CAL: 100%
    
```

Move the highlight over the “DONE” menu item and press the rotary button to return to the main menu.

```

--- VSI SETUP ---
*** DONE ***
ZERO VSI
VSI UNIT: ft/m
VSI CAL: 100%
    
```

This function is used to set your VSI to read exactly 0ft/min. This is similar to setting the needle on a mechanical VSI to point to zero by turning the adjustment knob on such a VSI. The electronic VSI generally has much less drift compared to a mechanical VSI and this function will only be used very occasionally. Ensure that you perform this function when no pressure changes due to wind or other reasons are occurring.

```

--- VSI SETUP ---
*** DONE ***
ZERO VSI
VSI UNIT: ft/m
VSI CAL: 100%
    
```

Select if you want your VSI readout in feet/minute (ft/m) or meters/second (m/s).  
**Note: meters/second will be shown with two decimals, example: “1.23”.**

```

--- VSI SETUP ---
*** DONE ***
ZERO VSI
VSI UNIT: ft/m
VSI CAL: 100%
    
```

This is a function that is used to calibrate your VSI to read exact rates of climb or decent. This function works as a percentage of initial reading. The default setting for this function is 100%. Increasing this value increases the VSI reading and decreasing the value decreases the reading.

### Suggested VSI calibration method

After you have installed the instrument, perform a calibration flight. This should be done in very calm conditions. Turbulence and thermal activity will make accurate calibration impossible. Many areas have ideal conditions during early mornings or late afternoons. Place the instrument in “feet” unit mode for ease of calibration. Take your aircraft to a few thousand feet above ground and start a glide with a low power setting. Take a stopwatch and when the glide is stable

(stable VSI reading) start the stopwatch. Take note of your altimeter reading at the same time. Continue the stable glide for one minute exactly. After the minute has finished, take another reading of your altimeter.

**Example:**

VSI reading during stable glide: -400 ft/min

Start altitude: 2500 ft.

End altitude: 2050 ft.

In the above example the VSI is under reading by about 12%. Set your VSI calibration to 112% to cancel out the error.



All the RPM related settings can be setup here.



Move the highlight over the "DONE" menu option and press the rotary button to return to the main menu.



Select whether you want the RPM low alarm to be turned on or off.



Enter the RPM alarm activation threshold. Any RPM value below this value will activate the alarm.



Select whether you want the RPM high alarm to be turned on or off.



Enter the RPM alarm activation threshold. Any RPM value above this value will activate the alarm.



Enter the number of pulses per RPM. For engines with an uneven number of cylinders like three cylinder four stroke engines you can enter values containing fractions (usually 1.5 in this example). Most four stroke engines would generate one pulse for every two revolutions per cylinder. A four cylinder automotive four stroke engine would thus generate 2 pulses per revolution. A typical Rotax DCDI two stroke engine would generate 6 pulses per revolution. The well known Rotax 912/914 engine generates one pulse per revolution.



PULSE: The FLIGHT-2 counts pulses from the engine for 1/2 second period (fast frequency input).  
TIME: The FLIGHT-2 uses the time between pulses to calculate revs (slow frequency input).

**Typical setups:**

Rotax 503,582 DCDI – Pulse (Fast frequency) (6 pulses per revolution)

Rotax 503 single ignition, Rotax 912/914 – Time (Slow frequency) (one pulse per revolution)

Gyro Rotor RPM with gear tooth sensor - Pulse (Fast frequency) (about 100 pulses per revolution)

Gyro Rotor RPM with single hall-effect sensor – Time (Slow frequency) (one pulse per revolution)

Helicopter Rotor RPM with single hall-effect sensor – Time (Slow frequency) (one pulse per revolution)

```

RPM SETUP
LOW ALARM: OFF
LOW ALM: 600
HIGH ALARM: ON
HIGH ALM: 5000
PULSE/REV: 6.0
PULSE: PULSE
FILTER: 10
    
```

The FLIGHT-2 unit contains a digital filter. This filter is used to achieve a higher resolution of the digital rev counter than is available in ordinary operation. In digital rev counters, resolution is largely dependent on the amount of time given to measure RPM. The more time that is available, the higher the resolution will be. However, on the downside of this, the more sluggish the display will react to changes in engine settings. Resolution with the FLIGHT-2 is dependent on the number of pulses per rev and the type of measurement method you have selected (Pulse Pulse/Time). The update rate for the measurement is a fixed, fast 0.5 seconds. The digital filter is activated whenever input revs are fairly constant and this results in a very high resolution of the digital RPM display in a short time span. The filter needs to be setup for the expected base resolution. This can be between 10 and 30 RPM for most setups. The filter has the following settings:

**10,20,30,40,50,60,70,80,90,100** – The filter factor can be set to any of these values independent of your scale selection. Choose a filter setting that results in a smooth, high resolution RPM display. A filter setting too low for your setup will result in a “jumpy” display. RPM display will change at your base resolution and no smoothing will happen. Choose the lowest setting that will result in a smooth display for greatest sensitivity of the reading.

### 5.10 Fuel Setup

```

MAIN MENU
FUEL SETUP
    
```

All the Fuel related settings can be setup here.

```

FUEL SETUP
*** DONE ***
UNIT: L/sm
SPEED: GPS-NMEA
BAUD: 4800
FLOW: ON
KFACTOR: 7000
LEVEL: $ENDER
    
```

Move the highlight over the “DONE” menu item and press the rotary control to return to the main menu.

```

FUEL SETUP
*** DONE ***
UNIT: L/sm
SPEED: GPS-NMEA
BAUD: 4800
FLOW: ON
KFACTOR: 7000
LEVEL: $ENDER
    
```

Select your desired units for distance and fuel quantity. The following options are available:  
 L/sm: Liters and statute miles  
 G/sm: U.S. Gallons and statute miles  
 L/nm: Liters and nautical miles  
 G/nm: U.S. Gallons and nautical miles  
 L/km: Liters and kilometers  
 G/km: U.S. Gallons and kilometers

```

FUEL SETUP
*** DONE ***
UNIT: L/sm
SPEED: GPS-NMEA
BAUD: 4800
FLOW: ON
KFACTOR: 7000
LEVEL: $ENDER
    
```

Select which speed will be used for range based calculations. You can select between “TAS” (True airspeed), “IAS” (Indicated airspeed) or “GPS-NMEA” (obtained from a RS232 NMEA enabled GPS receiver) .

```

FUEL SETUP
*** DONE ***
UNIT: L/sm
SPEED: GPS-NMEA
BAUD: 4800
FLOW: ON
KFACTOR: 7000
LEVEL: $ENDER
    
```

Select the Baud rate of your NMEA GPS receiver.

```

FUEL SETUP
*** DONE ***
UNIT: L/sm
SPEED: GPS-NMEA
BAUD: 4800
FLOW: ON
KFACTOR: 7000
LEVEL: $ENDER
    
```

Select if there is a fuel flow sender connected to the FLIGHT-2's fuel flow input.

```

FUEL SETUP
*** DONE ***
UNIT: L/sm
SPEED: GPS-NMEA
BAUD: 4800
FLOW: ON
KFACTOR: 7000
LEVEL: $ENDER
    
```

The K-Factor is the number of pulses generated by the fuel flow sender for one liter of fuel. The dual range fuel flow sender supplied by MGL Avionics has a K-Factor of 7000 in the low flow mode (jet installed) and 1330 for the high flow mode (no jet installed). The Flowscan 201A-6 has a K-Factor of 8454. You can use the K-Factor to calibrate your fuel flow sender. See the installation section for more details on how to calibrate and install the fuel flow sender.

```

FUEL SETUP
*** DONE ***
UNIT: L/sm
SPEED: GPS-NMEA
BAUD: 4800
FLOW: ON
KFACTOR: 7000
LEVEL: $ENDER
    
```

Select if the fuel tank has a physical fuel level sender connected to it or if the FLIGHT-2 must use a calculation based virtual fuel tank. If you do not want any fuel level information then set this parameter to off.

```

FUEL SETUP
UNIT: L/sm
SPEED: GPS-NMEA
BAUD: 4800
FLOW: ON
KFACTOR: 7000
LEVEL: SENDER
TANK SIZE: 45
    
```

Enter the size of the fuel tank in your system. It is recommended to choose a size that is slightly less than actual size so you can compensate for sender inaccuracies and give you a measure of reserve fuel.

```

FUEL SETUP
UNIT: L/sm
SPEED: AIRSPEED
FLOW: ON
KFACTOR: 7000
LEVEL: SENDER
TANK SIZE: 45
TANK CALIBRATE
    
```

See section 5.10.1 on how to calibrate the fuel level sender.

```

FUEL SETUP
SPEED: AIRSPEED
FLOW: ON
KFACTOR: 7000
LEVEL: SENDER
TANK SIZE: 45
TANK CALIBRATE
TANK FILTER:HIGH
    
```

Select the damping factor for the fuel level. A selection of none, low, med or high can be made.

```

FUEL SETUP
FLOW: ON
KFACTOR: 7000
LEVEL: SENDER
TANK SIZE: 45
TANK CALIBRATE
TANK FILTER:HIGH
ALARM: ON
    
```

Select whether to turn the fuel tank level alarm on or off.

```

FUEL SETUP
KFACTOR: 7000
LEVEL: SENDER
TANK SIZE: 45
TANK CALIBRATE
TANK FILTER:HIGH
ALARM: ON
ALARM VALUE: 10
    
```

Enter your desired minimum fuel value that you would like to trigger the fuel low alarm. The fuel low alarm will result in the flashing of the fuel level display and remaining fuel readout. You can also connect a warning lamp to the external alarm output (see installation diagram).

### 5.10.1 Calibrating the fuel level sender

```

TANK CAL: 0
*** DONE ***
MODE: SENDER
0L: 809
9L: 680
18L: 520
27L: 427
36L: 356
    
```

The fuel level sender needs to be calibrated before it can be used with this system. The calibration allows the system to learn the shape of your tank as well as any errors your fuel level sender or installation has.

Regardless of your use of a fuel flow sender, you can install a fuel level sender into your fuel tank. These level senders are inexpensive and are available as after market replacement fittings from a car spares outlet. We recommend the senders available from VDO.

**Be aware that some makes of cheap level senders can prove troublesome, as the lever arms tend to be sticky. This prevents the floats from floating on the surface of the fuel at all times. As a consequence, this will lead to incorrect fuel level indication.**

### Adjusting calibration points automatically

Select "SENDER" for the mode menu item. Once you have installed a fuel level sender into your tank, make sure the float can travel all the way from empty to full position without hindrance of any kind. The calibration procedure should be carried out with your aircraft in flight attitude. This means you need to lift the tail if you have a tail-dragger or lift the nose wheel if you have a weightshift trike.

#### Calibration procedure

- Start the calibration procedure with an empty tank.
- Add five liters of fuel (our reserve quantity) using a suitable measure. Make sure the measure is suitably accurate. This is now the "level sender reading at 0 Lt" position. Move the highlight to this position and wait until the sender reading has stabilized (You will see the sender reading at the top line). This could take up to a minute so have patience.

ENSURE THAT THE FLOAT IS NOT SUBMERGED AND IS FLOATING ON TOP OF THE FUEL LEVEL.

Should this number not react to changes of your level sender position, then you have a problem. Please check your wiring according to the installation section of this manual. You should expect the number to change in the

region of at least 20 to 60 counts per calibration position. If the number does not change with fuel level or only changes a very small amount – check your installation. Something is not right!

- If you see the number changing then everything is well. Once it has stabilized and the highlight is on the 0 L position, press the rotary control to transfer the reading from the sender to the calibration point.
- Now you are ready for the next step. Add the required amount of fuel to get to the next level (In our case 9 Lt – this is 20% tank capacity). Once done, wait for the reading to stabilize and press the rotary control again after you have moved the highlight to the “9 L” position.
- Proceed in a similar manner until you have reached the last calibration position at 100% tank capacity.

You are done!

**To finish your calibration, exit the calibration function by moving the highlight over the “DONE” menu item and press the rotary control.**

The instrument uses the 6 calibration points to work out a correction curve that takes into account the tolerances of your fuel level sender and the shape of your fuel tank. This results in an incredibly accurate and usable fuel level display that far exceeds that available from ordinary dial type gauges.

### Adjusting calibration points manually



You may want to set individual calibration points manually. For example you may find that your fuel level is over reading at a specific fuel level. Correcting the tank level reading for this area can be simply done by adjusting the calibration point. You can do this by moving the float level with your hands to the desired position and then performing the calibration as outlined above, or you can use the manual option.

Select “MANUAL” for the mode menu item. Then highlight the point you want to change manually and press the rotary control. Use the up or down keys or the rotary control to adjust the value. Press the rotary control when done.

**Note:** The calibration positions may be edited by using the up and down keys. This allows you, in theory, to copy calibration settings from one instrument to another. We however recommend that you do go through the calibration procedure even if the two aircraft are identical in all respects. Tolerances do exist and the calibration cancels these out. Accurate fuel level displays are a vital safety factor for an aircraft and a very useful feature for peace of mind during cross county flights.

### Notes on Slope error



Sender value is a value determined by the FLIGHT-2. It is used to calculate fuel level, fuel endurance estimate and current range estimate. The fuel tank setup sender value can either increase in value as fuel is added or decrease in value if fuel is added. This is dependent on the type of fuel level sender used. However should the second reading be larger than the first reading all readings will have to be larger than the previous readings. Likewise should the second reading be smaller than the first reading all readings will have to be smaller than the previous reading.

If this is not the case the wording "Slope error" will be displayed. This could happen when fuel was removed instead of added between steps, no fuel was added between steps or when the fuel level sender was moved in the wrong direction e.g. moving the fuel level sender manually when it is not inserted in to the fuel tank. Determine the cause of the error if you should get a slope error message. If you do not know the cause of your error it is best to start from scratch. It should be remembered that accuracy in the fuel tank calibration is extremely important to enable your FLIGHT-2 to display the correct data.



## 5.11 Voltage Setup



Move the highlight over this menu item and press the rotary button to return to the main menu.



Select whether you want the voltage alarm to be turned on or off.



Enter the low voltage set-point for when the alarm must be activated. Any voltage below this value will activate the alarm.



Enter the high voltage set-point for when the alarm must be activated. Any voltage above this value will activate the alarm.



## 6 Loading factory default settings

Pressing and holding the F1 and F2 simultaneously on power up will cause the FLIGHT-2 to load preprogrammed factory default settings. The following screen will be displayed:

```

LOADING
DEFAULT
SETTINGS
  
```

## 7 Operating the alarms

If the alarm is activated, the corresponding item on the display will flash. At the same time the externally available alarm switch will close. The switch will remain closed until any button is pressed to acknowledge the alarm or until the condition(s) that activated the alarm no longer exist. The alarm output can be used to switch an external alarm indicator. The external alarm switch is an open collector transistor switch to ground with a maximum rating of 0.5A DC. It is possible to wire the alarm contacts of several Stratomaster instruments in parallel should this be desired. To avoid false activation of the alarms, the alarm function is only active 10 seconds after the instrument has powered up.

## 8 Cleaning

The unit should not be cleaned with any abrasive substances. The screen is very sensitive to certain cleaning materials and should only be cleaned using a clean, damp cloth.

**Warning:** The FLIGHT-2 is not waterproof. Serious damage could occur if the unit is exposed to water and/or spray jets.

## 9 FLIGHT-2 Specifications

<b>Operating Temperature Range</b>	-10°C to 50°C (14°F to 122°F)
<b>Storage Temperature Range</b>	-20°C to 80°C (-4°F to 176°F)
<b>Humidity</b>	<85% non-condensing
<b>Power Supply</b>	8 to 30Vdc SMPS (switch mode power supply) with built in 33V over voltage and reverse voltage protection
<b>Current Consumption</b>	Approx. 52mA @ 13.8V (backlight on) 24mA @13.8V (backlight off)
<b>Display</b>	128x64 graphic LCD display. Contrast and backlight is user configurable, green/yellow backlight
<b>Dimensions</b>	see Velocity series dimensional drawing
<b>ADC</b>	12bit over sampled successive approximation
<b>Enclosure</b>	3 1/8" ABS, black in color, front or rear mounting
<b>Weight</b>	Approx. 198 grams
<b>Alarm contact current rating</b>	Open collector transistor switch to ground. Maximum rating 0.5A DC
<b>Non-volatile memory storage</b>	100000 write cycles
<b>Altimeter</b>	
<b>Altimeter range</b>	-700ft to 30 000ft (-213m to 9144m)
<b>Altimeter resolution</b>	1ft/1m
<b>Altitude measurement accuracy</b>	+/- 1mB, +/- 30ft at sea level
<b>Airspeed</b>	
<b>Airspeed range</b>	16mph to 250mph
<b>Airspeed resolution</b>	1 mph
<b>Measurement accuracy</b>	+/-1% at 85mph nominal
<b>VSI</b>	
<b>Digital VSI range</b>	+/-20ft/m to +/-10 000ft/m
<b>Digital VSI resolution</b>	10ft
<b>VSI measurement accuracy</b>	+/- 2%, relative to calibration
<b>RPM</b>	
<b>Rev counter input</b>	Range: 0-20000 RPM. Minimum signal for stable display: 5Vpp. Fully A/C coupled, maximum voltage +/- 40V. RF noise filter plus Schmitt-trigger based input
<b>Fuel</b>	
<b>Fuel level input</b>	Maximum voltage: 5V, 5mA maximum current
<b>Fuel level senders supported</b>	Any resistive type with common ground and capacitate probes with active voltage outputs up to 5V level (push pull or pull-up)
<b>Fuel flow senders</b>	Supply +5V, 40mA maximum current. TTL level input with noise filter and Schmitt-trigger hysteresis. Required input voltage swing: less than 1.5V to more than 3.5V. Maximum input voltage range -5V to +18V
<b>Airtalk protocol</b>	19200 baud, 8 data bits, no parity, 1 stop bit (TTL voltage levels)
<b>NMEA Baud rate</b>	Selectable - 1200,2400,4800,9600,19200
<b>Voltage</b>	
<b>Range</b>	8 to 30V DC
<b>Resolution</b>	0.1V

## 10 Installation

### 10.1 Altimeter Installation

Connect the static port to a suitable static air pressure line. If you have a slow aircraft or an aircraft where the internal cabin pressure does not change during flight and is equivalent to the outside air pressure you may find that it is not required to connect a static port.

For installations in typical ultralight aircraft pods, be aware of possible pressure changes inside the pod during flight caused by ram air or suction effects. This may lead to a false indication of altitude and airspeed. Often these effects are dependent on the current angle of attack of the airflow around your pod. You will need to install a suitable static port in these cases.

Static ports are usually mounted at a strategic position on the rear side of the aircraft fuselage for faster, pressurized aircraft.

### 10.2 Airspeed Installation

Connect your pitot tube to the “pressure port”. Pitot tubes are found in a large variety at your aircraft parts shop, in mail order catalogs or you can make your own. Contrary to popular belief, pitot tubes are not carefully designed and calibrated, but are simple orifices or tubes that get pointed in the direction that you are flying. The forward movement of the aircraft causes air to dam inside the pitot tube. This increases the pressure inside the tube.

Suitable pitot tubes can be made from a short piece of hollow aluminium or copper piping. Length and diameter are not important. Ensure that the front of the pitot tube has a suitable chamfer if you use thick walled tubing or you may introduce a speed reading error if you have a faster aircraft.

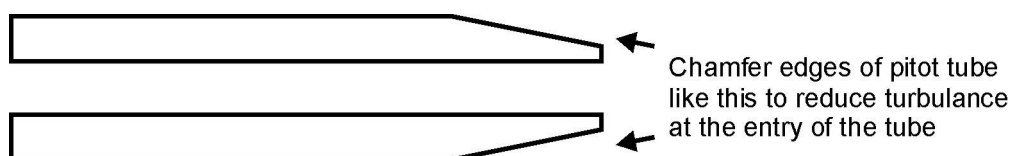

#### Example cross-section of thick walled pitot tube.

Suitable connection hose for both pitot tube and static port can be obtained from a hardware store or even a pet shop. Good quality tubing is often used for fish tanks and it has just the right diameter. Please note that this kind of tubing is not advised for pressurized aircraft. In this case you would need to obtain aircraft grade tubing of suitable diameter. You would also have to use hose clamps to fasten the hose onto the FLIGHT-2 pitot and static ports. The FLIGHT-2 allows you to calibrate the airspeed reading. This is done in the “Calibrate” menu item. The main reason for this is to be able to remove errors introduced due to the airflow around your aircraft which may have an effect of your pitot tube pressure.

### 10.3 Fuel flow sender installation

The fuel flow sender allows the FLIGHT-2 to provide instantaneous readouts of hourly fuel usage, and both time and distance estimates on remaining fuel in flight. You can also verify the performance of your fuel pump during the pre-takeoff engine run up – a very valuable check! Further, it is possible to set up the instruments to calculate fuel remaining by subtracting fuel used from a value entered when you filled your tank(s). In this case you may omit the installation of the optional fuel level sender. Please note that the installation of the fuel flow sender should be done in such a fashion that dirt or debris from the fuel tank cannot lodge inside the flow sender. These will not block your fuel flow but may lead to the impeller inside the sender jamming. It is usually sufficient to mount the flow sender **AFTER** the fuel filter but before the fuel pump. It is a good idea to provide a small reservoir such as a primer bulb between the flow sender and the fuel pump.

As indicated in the recommended installation drawing, it can be of advantage to install the flow sender in such a fashion that the inlet points slightly down and the outlet points slightly up. This prevents vapor from forming a bubble inside the flow sender. We strongly recommend mounting the flow sender in such a fashion that the impeller rests on only one bearing. This is achieved if you mount the sender such that the surface with the arrow faces upwards. Mounting the sender like this results in the best performance at low flow rates as only very little friction is present. The flow sender is delivered with a small jet that can be installed in the flow sender inlet. Installation of this jet is recommended for engines with fuel flow rates lower than about 30 liters per hour. This would apply to most small two and four stroke engines. The FLIGHT-2 is shipped with the fuel flow sender calibration set for the jet installed. In a good installation you can expect about +/- 3% maximum flow reading error with this factor. You can calibrate the flow sender yourself to a higher degree of accuracy if you so desire.

Recommended procedure to calibrate the fuel flow sender:

**Note:** You must disable the fuel level sender if you have one installed, and enable the calculated fuel level sender.

1. Fill your tank exactly to a known level (for example 50 liters).
2. Set your fuel level to 50 liters.
3. Fly your aircraft for a period that you know will use approximately 20 liters of fuel. The exact fuel burn is not important; just burn about 20 liters of your fuel. At the end of your flight the instrument should give you a reading of how much fuel you have left – the reading should be about 30 liters left.
4. Now place your aircraft in exactly the same position that you used when you first filled the tank and refill the tank to 50 liters using a measuring jug. You should find that you need 20 liters of fuel to refill to 50 liters.
5. If you find that the instrument under or over reads the fuel used, you should perform a simple adjustment of the fuel flow sender calibration factor.

### Example:

Actual fuel used: 21.5 liters, FLIGHT-2 fuel burn calculated 29.7 liters left in the tank. This means the FLIGHT-2 measured  $50 - 29.7 = 20.3$  liters. We are under reading by 1.2 liters.

Default calibration factor in Fuel setup menu = 7000.

Let the corrected calibration factor be X.

$$X = (20.3 * 7000) / 21.5$$

$$X = 6609.3$$

The closest setting you can enter as factor is 6609. Enter it into the unit and you are done!

Repeat the above procedure to verify that your flow sender is now reading correctly.

### Please note:

Before you calibrate the flow sender ensure there are no problems with your installation. We find the senders are very accurate if everything is installed and working properly. If your fuel burn indication is out by a large amount you have a problem that you should not attempt to fix by fiddling with the calibration factor! Please ensure that no fuel vapor can be trapped inside the sender housing in the form of bubbles. Due to the low fuel flow rates the bubbles will prevent the tiny impeller from turning freely, you can verify the turning of the impeller. You should notice three dark spots that are just visible in the inside of the fuel flow sender. These are small magnets that are attached to the impeller. With fuel flowing you should see the magnets turning. The best defense against vapor bubbles is to install the flow sender in such a way that the bubbles can escape. The easiest way is to point the outlet slightly upwards and the inlet (with the jet) slightly downwards. Another possible problem is the fuel sender jet. When you install it, do not damage it. Use a drill bit of suitable diameter (5.5mm) to push the jet all the way, the opening of the jet must be just in front of the impeller.

YOU NEED TO APPLY SOME FORCE TO INSERT THE JET ALL THE WAY (about 24mm). THE JET MUST BE LOCATED RIGHT IN FRONT OF THE IMPELLOR. YOU CANNOT PUSH THE JET TOO FAR.

## Using other Flow Senders

It is quite possible to use flow senders other than the MGL Avionics fuel flow sender. In this case ensure that the sender outputs a 5V TTL square wave or a similar signal. The FLIGHT-2 interface electronics will adapt to a variety of different voltages and pulse shapes as it contains a Schmitt-trigger input stage. The calibration factor can be entered in a wide range making the unit particularly suited to other flow senders. The supply output terminal for the sender provides a positive, regulated 5 volt output. This may be used to power the flow sender provided the sender will not draw more than 40 mA of current. Should your sender require a higher voltage or more current, you must supply the sender from a different power source. Exceeding the rating on the MGL Avionics fuel flow sender supply terminal can affect the operation on the unit negatively or even damage it. Some senders require a pull-up resistor to the 12V supply line. We find most installations of these senders require a 4K7 pull-up resistor.

Recommended Calibration Factors for the MGL Avionics dual range flow sender:

With jet installed = 7000. Recommended for flow rates below 30 liters/hour maximum

Without jet installed = 1330. Recommended for flow rates above 30 liters/hour

Please refer to the leaflet included with the flow sender for information on pressure drop versus flow rate, wetted materials etc.

**It is your responsibility to ensure that the flow sender used is compatible with the fuels you intend using. We have found the MGL Avionics fuel flow sender to be very compatible with automotive fuels used in South Africa, many of which contain methanol. 100LL AVGAS also appears not to harm the sender in any way. We have exposed a sender continuously to our automotive fuels for the duration of two years without any noticeable ill effect on the sender. However, despite this MGL Avionics or its appointed agents cannot assume responsibility for any incident or damage, even loss of life by whatsoever cause connected with the fuel flow sender or the FLIGHT-2 instrument. Usage of this or other senders is your own sole responsibility.**

**If you do not agree with the above statement you must not use the fuel flow sender.**

**Note to Pilots:** (Even though this is the installation manual)

You must always have a visual indication of the fuel level available, either by means of a sight glass, direct tank observation or a known, reliable secondary fuel level gauge. Fuel level indication by means of calculated fuel burn is subject to errors both by entering incorrect starting fuel levels as well as mechanical problems causing the flow sender impeller to turn too slowly, resulting in under reading fuel burn and thus over reading remaining fuel. As pilot in command of an aircraft it is your responsibility to ensure that you have sufficient fuel to reach your intended destination. Always ensure that you have a generous amount of reserve fuel and never use your reserve fuel except in an emergency if it is unavoidable.

## 10.4 Floscan 201 fuel flow sender installation

1. The inlet and outlet ports in series 201 flow transducers have ¼" NPT threads. Use only ¼" NPT hose or pipe fittings to match. When assembling fittings into the inlet and outlet ports DO NOT EXCEED a torque of 15 ft. lbs. (180 inch lbs.), or screw the fittings in more than 2 full turns past hand tight, WHICHEVER COMES FIRST. FloScan Instrument Co., Inc. will not be responsible for cracked castings caused by failure to use ¼" NPT fittings, over torquing the fittings, or assembling them beyond the specified depth.
2. A screen or filter should be installed upstream of the flow transducer to screen out debris which could affect rotor movement or settle in the V-bearings. As turbulence upstream of the transducer affects its performance, there should be a reasonable length of straight line between the transducer inlet and the first valve, elbow, or other turbulence-producing device.
3. Install the flow transducer with wire leads pointed UP to vent bubbles and insure that rotor is totally immersed in liquid. For maximum accuracy at low flow rates the transducer should be mounted on a horizontal surface.
4. Power supply: 12 VDC at 100mA filtered and regulated.
5. Series 200 flow transducers are designed to measure steady state flows. Indicated accuracies and pulse counts were obtained using heptane on a flow stand with rotary pumps and are reproducible in flow systems using rotary or gear pumps. Fuel systems with diaphragm fuel pumps and carburetors produce pulsating fuel flows. For accurate results on these systems consult the factory for the correct flow transducer/pulsation damper combination.

**Wiring the Floscan Flow Transducer**

The FLIGHT-2 unit measures the output from the transducer. A 5600 ohm (5k6) pull-up resistor is required. See wiring table and installation diagram below.

The gallon per hour K-Factor for the 201A-6 transducer is approximately 32,000. The K-Factor of each sensor (at 16 GPH), divided by 10, is written on a label attached to sensor. Multiply this number on the label by 10, which should give a value of approximately 32,000. The FLIGHT-2 requires a litre per hour K factor. Take the gallon per hour K factor, and divide it by 3.785 (which yields a K-Factor of approximately 8454).

Floscan transducer wire color	FLIGHT-2 DB9 Terminal/Other Terminal
White	Fuel flow sender (DB9 pin 8 – yellow)
Black	FLIGHT-2 ground (DB9 pin 1 – Black) / Aircraft ground / Engine block
Red	+12V DC Supply (Not supplied by the FLIGHT-2)

**Floscan connection diagram**

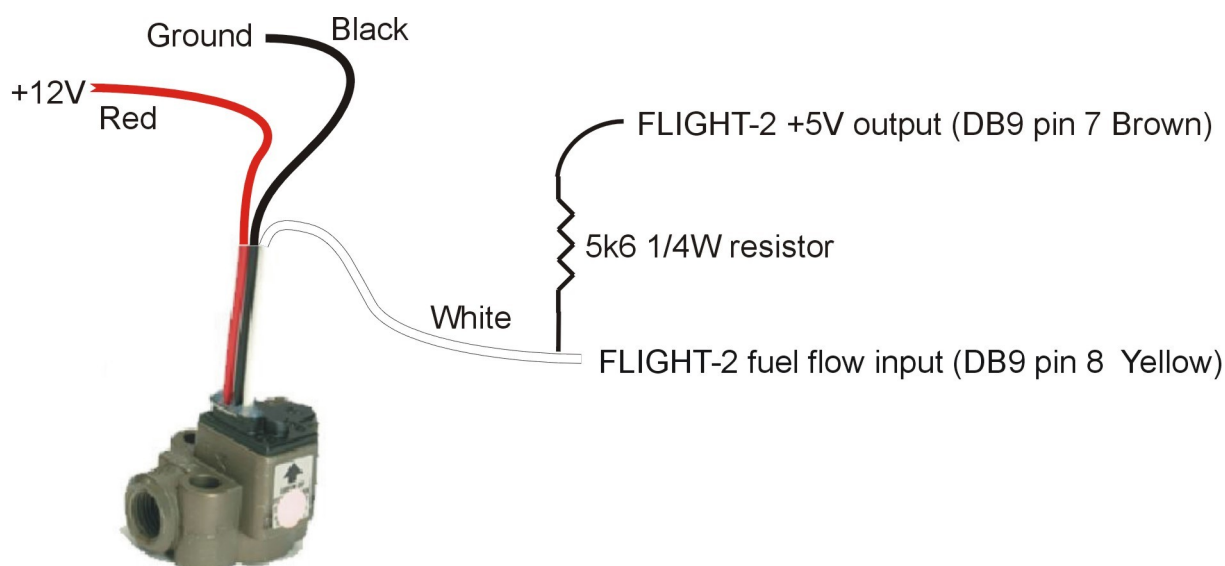

	Model 201A-6	Model 201B-6	Model 201C-6
<b>Flow range: Gasoline</b>	0.3 – 30 GPH	0.6 – 60 GPH	2.0 - 80 GPH
<b>Flow range: #2 Diesel</b>	2.0 – 30 GPH	3.0 – 60 GPH	8.0 – 80 GPH
<b>Approximate K-Factor<sup>1</sup>: Gasoline</b>	32 000	28 000 – 31 000	24 000
<b>Approximate K-Factor<sup>1</sup>: Diesel</b>	33 000	28 000	25 000
<b>Pressure Drop: Gasoline</b>	0.6psi @ 15 GPH 2.4psi @ 30GPH	1.2psi @ 30 GPH 4.8psi @ 60GPH	1.4psi @ 40 GPH 5.8psi @ 80 GPH
<b>Pressure Drop: #2 Diesel</b>	0.8psi @ 15GPH 3.0psi @ 30GPH	1.5psi @ 30GPH 6.0psi @ 60GPH	1.8psi @ 40GPH 7.2psi @ 80GPH
<b>Repeatability between measurements</b>	0.25% @ 16GPH	0.25% @ 16GPH	0.25% @ 16GPH
<b>Working pressure</b>	200psi	200psi	200psi
<b>Temperature range</b>	-65°/100°C	-65°/100°C	-65°/100°C
<b>Bearing life expectancy</b>	10 000 hr min.	10 000 hr min.	10 000 hr min.

**Notes:**

1. Pulses/Gallon @ 16 GPH
2. All flow transducers are tested and marked with K-factor at 16 GPH. Repeatability at 16 GPH is guaranteed to 0.25%. Transducers are available with calibrated K-factors at additional cost

## 10.5 Fuel level sender installation

The FLIGHT-2 permits the connection a standard automotive fuel level sender. These senders can be obtained at automotive spares outlets at reasonable cost. When you choose a float level sender, ensure that you select a model that is sturdy and promises reliable and long lifetime. In particular, select a model that does not have any metal parts that can rust. The FLIGHT-2 can interface to a large variety of these fuel level senders. It does not matter if the sender resistance increases or decreases with the fuel level as long as it changes. The calibration procedure outlined in the "Fuel Setup" section describes in great detail the procedure to follow.

In essence, the calibration procedure will measure the resistance of the fuel level sender at various fuel levels and then work out the readings in between those known settings. Typical fuel level senders that can be used with the FLIGHT-2 have resistance ranges in the region of 100 ohms to 500 ohms. Connect the flange of the sender to the negative supply (ground). You can connect capacitive senders as well. These generally come in two types: The first emulates a normal resistive probe and is simple to connect and use as a result. The second type has a voltage level output. These can be used if the voltage can be set to a range of about 0-5V. Higher voltage levels will result in the instrument assuming a problem.

We recommend using VDO float based fuel level senders. Capacitive types can be used provided they have a voltage output not exceeding 5V. The level terminal has an internal 1K resistor pull-up to +5V. Please note that capacitive senders may exhibit large errors as they are very sensitive to the composition of the fuel used. We do not recommend using capacitive senders with automotive fuels for this reason.

**Safety Hazard! Please take note:**

Be careful when installing fuel level senders into fuel tanks. Ensure that the fuel tank is completely empty when you proceed with the installation. Ensure that the fuel tank is well ventilated and does not contain any fuel vapors – these are highly explosive when mixed with air. Ensure that at all times the ground connection (the connection of the fuel level sender mounting flange) is securely connected to the aircraft frame (in case of a metal frame) and to the negative terminal of the battery. In addition the negative terminal of the battery must at all times be connected to the supply ground terminal of the FLIGHT-2. Please note – this wiring is critical and must never break in flight. It would be possible to create electrical sparks in the fuel tank if your wiring is faulty or incorrect. The consequences of this can be imagined. This has nothing to do with the FLIGHT-2 itself but is a general hazard for any automotive fuel level sender installation. If you have no experience with electrical wiring, **PLEASE** delegate the task to a qualified automobile electrician or electronics technician. If you need to remove the FLIGHT-2, please first disconnect and secure the fuel level sender wire before disconnecting anything else.

## 10.6 RPM Installation

### 10.6.1 About RPM Measurements

Generally, there are two different methods of measuring RPM. The FLIGHT-2 unit can be setup to perform either method. The first method involves counting pulses generated by some device in the engine or from a sensor in case of Rotor RPM. Pulses are counted over a period of time and the result is then used to calculate RPM. This method requires a high number of pulses and a short measurement interval. The FLIGHT-2 counts pulses for ½ second. This method is suitable for most two stroke engines such as produced by Rotax.

Engines producing few pulses (perhaps only one pulse per revolution) and run at low revs, as well as slow turning rotors require a different method. Here the FLIGHT-2 can use the time it takes to generate only two pulses as bases for the RPM calculation. The particular method to be used and the number of pulses per revolution are entered as part of the FLIGHT-2 setup as given below.

## 10.6.2 RPM Installation

After you have connected the rev counter terminal to the signal source you need to set the number of pulses per revolution under the “RPM SETUP” menu. The calibration itself depends on your engine type and what kind of signal you are using. Typical sources are:

- Magneto coils (suitable signal at the kill switch)
- Primary (low voltage) side of ignition coil, at contact breaker or electronic ignition module
- RPM counter output of electronic ignition systems (for example Bosch Motronic)
- RPM pickup devices such as hall-effect sensors on flywheels etc.

Installation of the FLIGHT-2 is quite straight forward in most cases. The drawing in section 10.8 shows a typical FLIGHT-2 installation. Please see the engine connection diagrams for the RPM connection to the FLIGHT-2. The FLIGHT-2 input is quite universally usable. The rev counter input on the FLIGHT-2 can be used with signals from about 5Vpp to as much as 100Vpp and the input is AC coupled for easy installation. A noise filter is included that results in the input ignoring any noise signals as long as this is below the detection threshold of about 2.5Vpp. The input impedance of the rev counter input is approximately 10Kohm. You can use series resistors as well as load resistors for applications that have unusual signals.

For installations such as with the Rotax DCDI two-stroke engines, the rev counter input is simply connected to the grey rev counter wire from the engine. These engines produce six pulses per rev (set this up in the relevant menu item). Most engines produce 0.5, 1 or 2 pulses per revolution. This needs to be setup in the “RPM SETUP” menu item.

**Please note: The +5V supply line is unprotected and intended only for the supply of a hall-effect , optical or gear tooth sensors. Connecting any voltages (such as the 12V supply) to this line could destroy the instrument. The +5V line may supply currents of up to 40mA. Should your sensor require greater currents you must supply it from another source.**

**Please note: It is essential that a single wire be connected from the minus terminal of the instrument to the engine block. This wire must not be used to share currents with other electrical users as this can affect accuracy of readings.**

## 10.6.3 Adjusting RPM sensitivity

The FLIGHT-2 has a sensitivity adjustment trimmer as shown in the picture below. Adjust this trimmer using a small screwdriver such that you get stable RPM readings over the entire rev band of your engine. If your sensitivity is too high, you may get unstable RPM readings (usually at higher RPM as electrical noise in the ignition system increases). If the sensitivity is too low the RPM reading may remain at zero. Fully clockwise = maximum sensitivity.

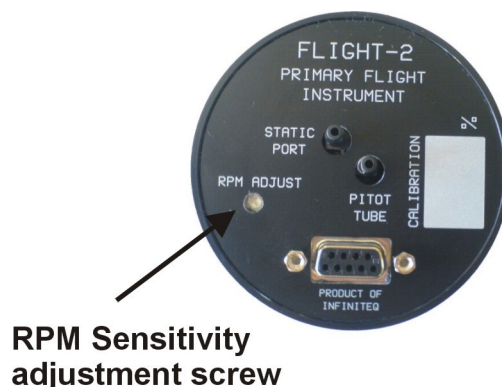



10.6.4 Connecting the FLIGHT-2 to automotive engines

Conventional contact breaker ignition system

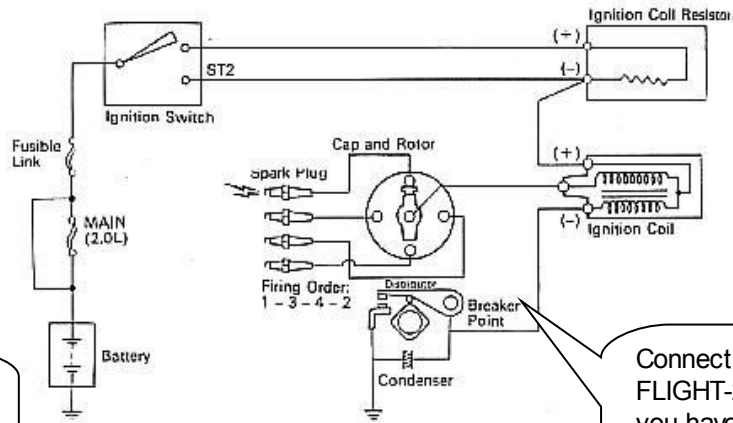

Use the tach line if your system has such a signal

Connect rev counter input of FLIGHT-2 to this line. Ensure you have a connection from the FLIGHT-2 ground to the engine block.

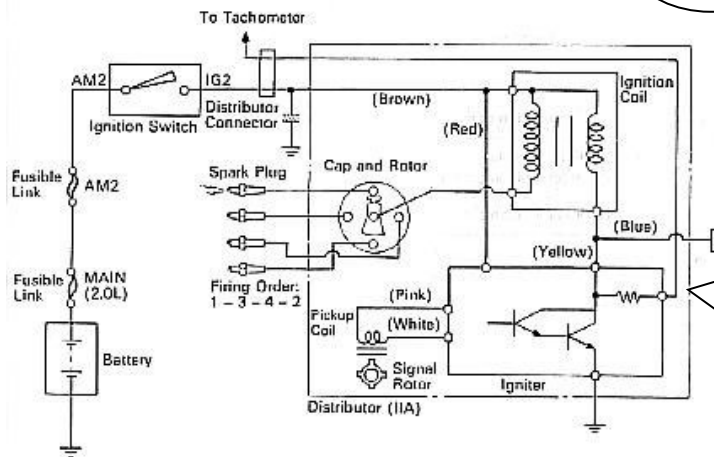

Connect rev counter input of FLIGHT-2 to this line. Ensure you have a connection from the FLIGHT-2 ground to the engine block.

Electronic ignition system with conventional ignition coil

## 10.6.5 Connecting the FLIGHT-2 to a 2 stroke Rotax engine

Typical connection in case of a Rotax two stroke engine with Ducati dual ignition:

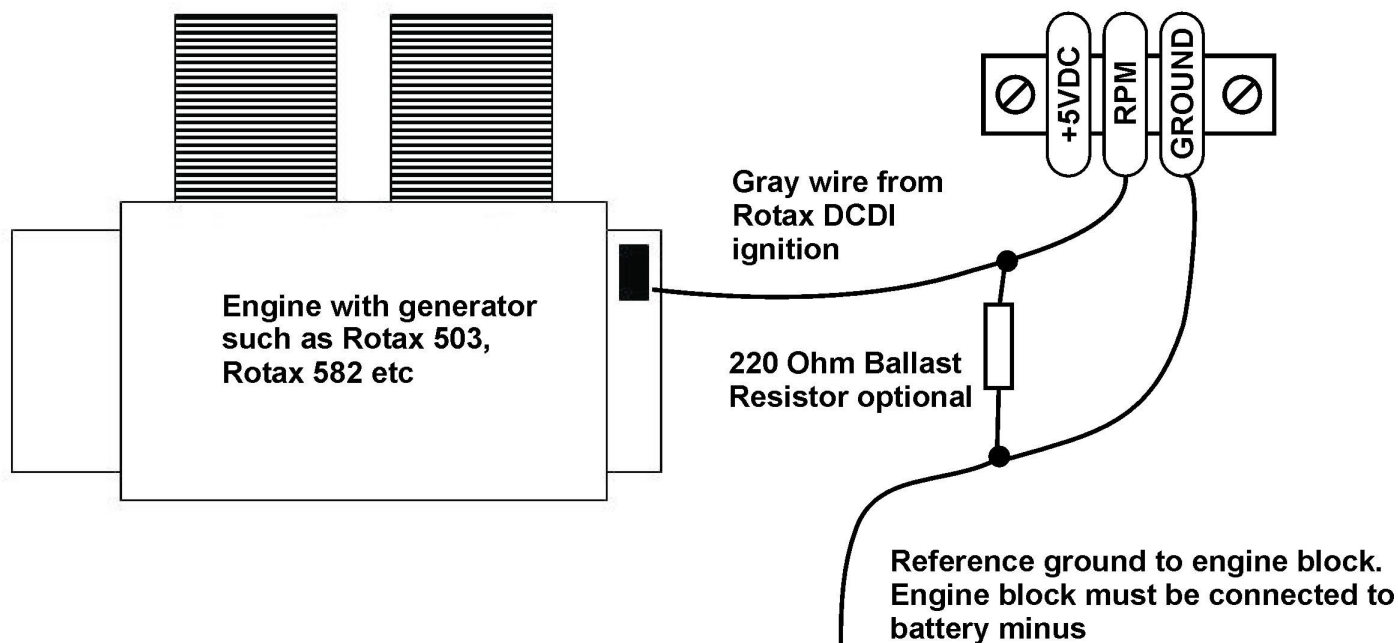

The follow values must be used for the pulses per revolution under the "RPM SETUP" menu.

**Rotax 503,582,618 DCDI** - value 6.0

**Rotax 912,914** - value 1.0

**Note:** Some Rotax engines may require that a 220 ohm ballast resistor is fitted between the rev counter input and the ground terminal. This resistor should be fitted if you cannot obtain stable RPM throughout the range regardless of any setting of the rev counter sensitivity adjustment.

10.6.6 Connecting the FLIGHT-2 to a Rotax 912/914

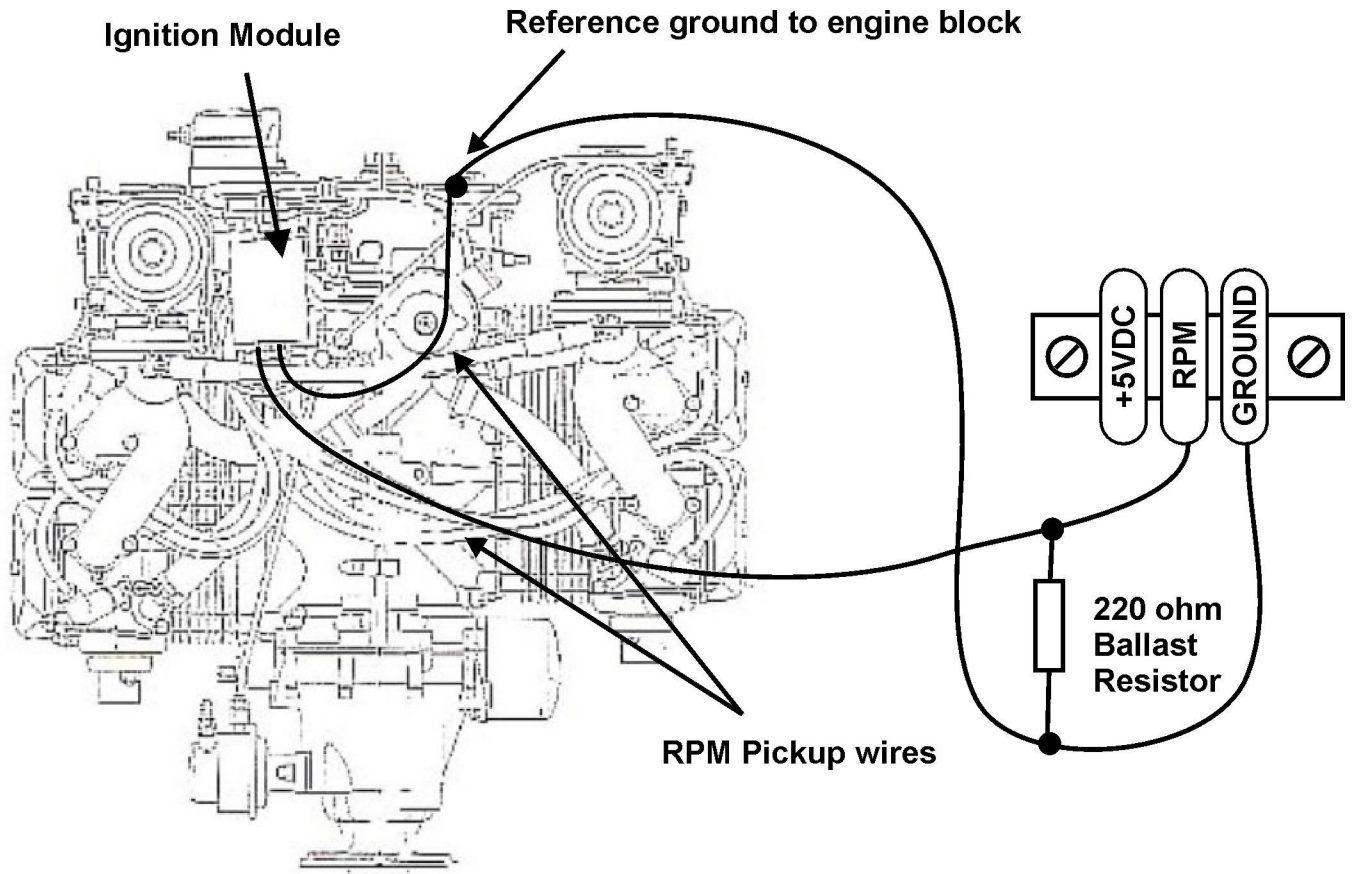

Connect the rev counter wires (blue/yellow and white/yellow) as follows: One of the two wires needs to be connected to ground (engine block), the other to the RPM counter input. For this engine we recommend that you use the supplied 220 ohm ballast resistor. Select a value of 1.0 for pulses per revolution under the "RPM SETUP" menu.

### 10.6.7 Connecting a Bendix magneto as a RPM source

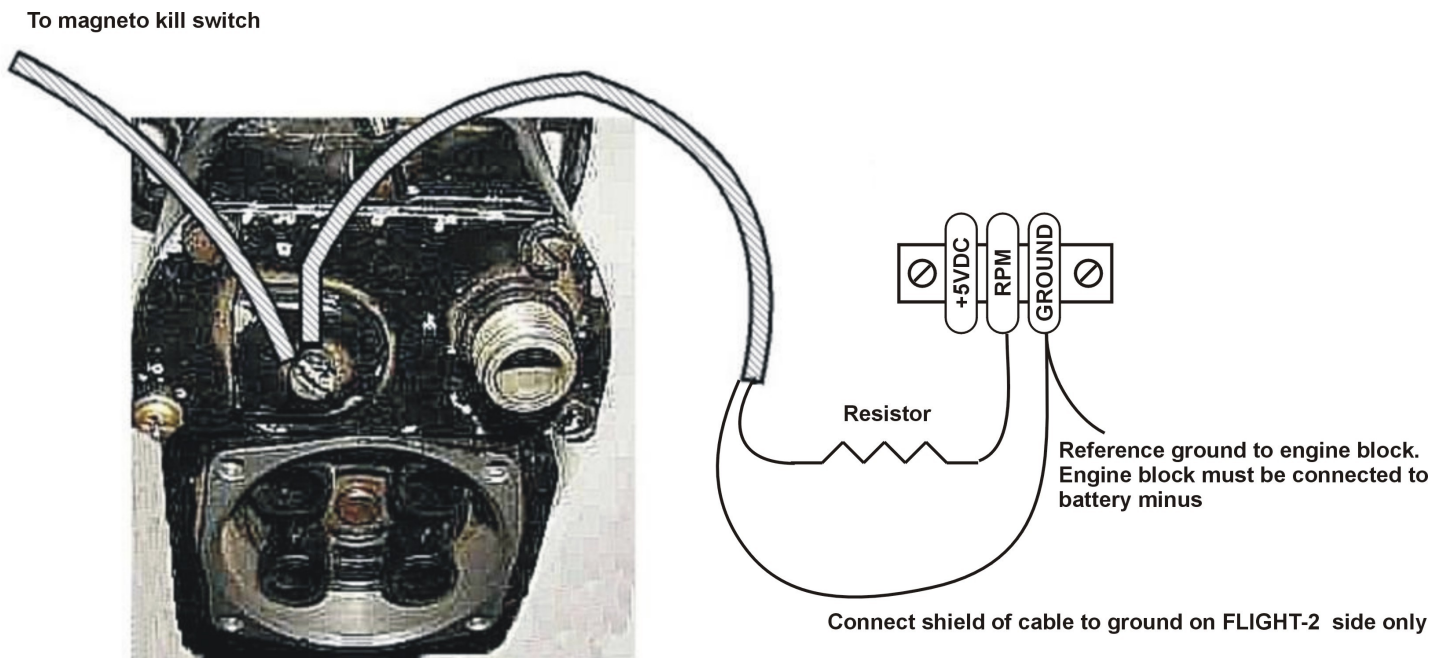

Typical connection to a Bendix P-Terminal.  
This terminal will have a wire going to your  
magneto kill switch or starter switch. Please  
note that various kinds of terminals are used  
on the many different types of Bendix magnetos

The above drawing shows the connection required if you would like to connect a magneto as RPM source. Shown is a typical Bendix magneto as used on Lycoming and other aircraft engines. You should find a wire connected to a terminal on the magneto that originates from your magneto kill switch (or starter switch). The terminal is often referred to as a "P-terminal". Connect a wire as shown and connect this to the RPM input of the FLIGHT-2. We strongly recommend that a resistor is inserted into your wire as shown. A good value would be 10.000 ohms (10K). A normal 1/4 W resistor is just fine. The above circuit can also be used on other magneto systems such as found on Jabiru and similar engines.

The supplied 220 Ohm ballast resistor should not be used on the above installation.

### 10.6.8 Various other pickup/sensor installation possibilities

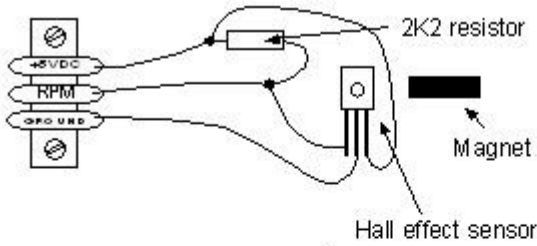

Typical hall effect sensor installation detects the passing of a magnet suitably fixed to prop flanges or shafts.

Magnetic pickup with Hall effect sensor

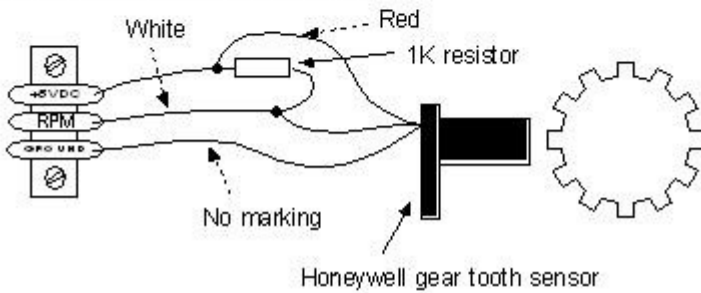

The gear tooth sensor is a popular pickup used on the pre-rotation gear of a gyro plane (rotor speed indication).

Magnetic pickup with active gear tooth sensor

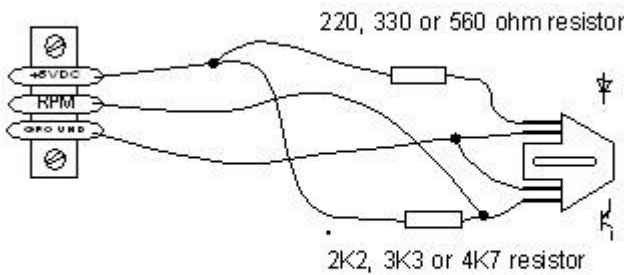

The optical reflective pickup can provide a simple means of contactless RPM sensing in difficult installations.

Optical, reflective sensor

### 10.7 FLIGHT-2 DB9 Cable connections

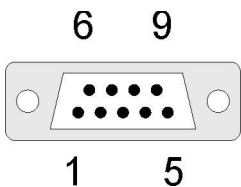

DB 9 Pin	Color	Function
1	Black	Ground
2	Orange	Fuel level sender input
3	Green	OAT Sender
4	NC	Airtalk communication (Not connected) Used for firmware upgrading
5	Blue	RPM input
6	Red	8-30Vdc power
7	Brown	+5VDC Power Out
8	Yellow	Fuel flow sender input
9	White	Alarm Output

### 10.8 FLIGHT-2 General Connection Diagram

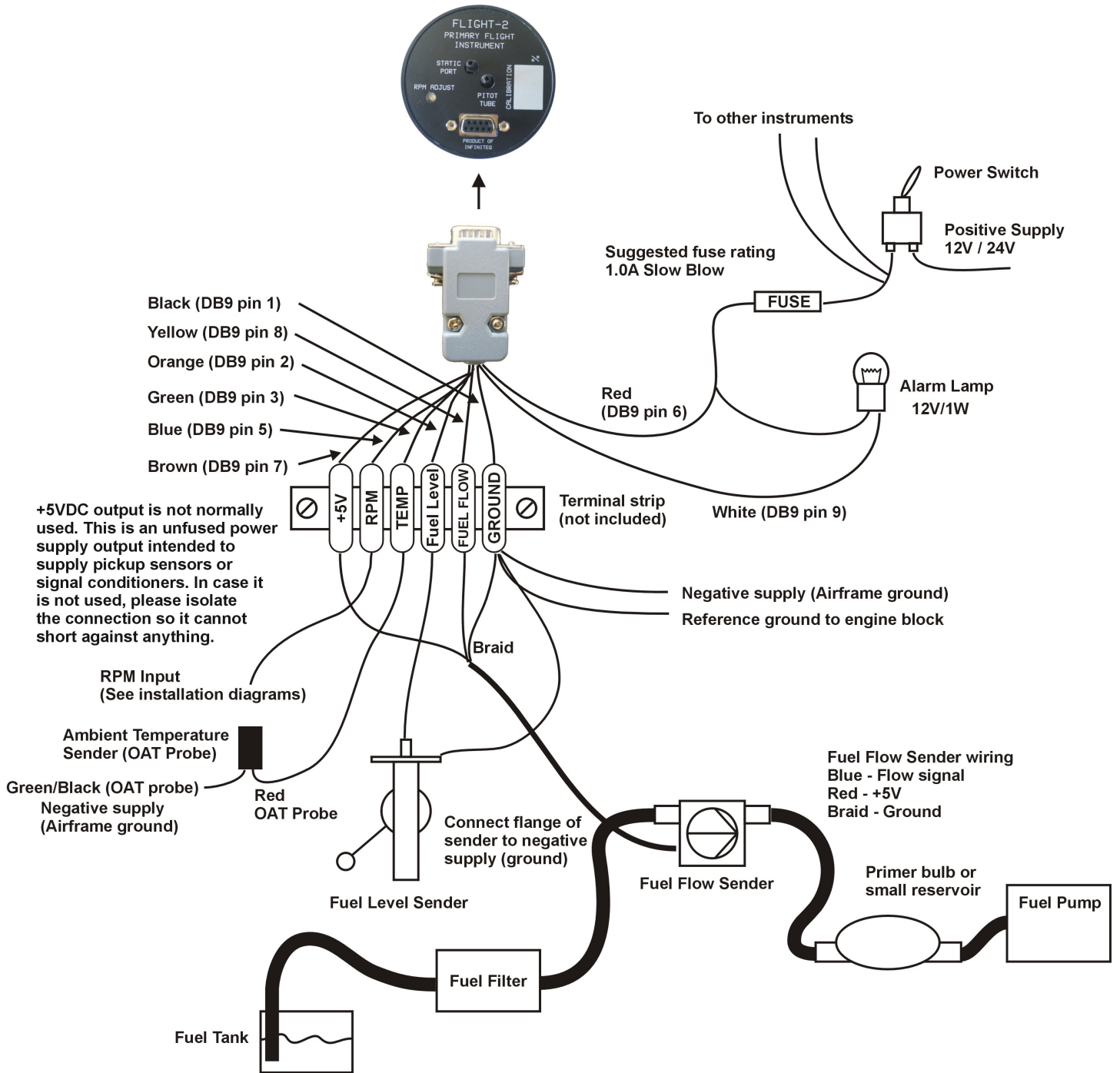

The use of an external 1A fuse is recommended. Connect the supply terminals to your aircraft's power supply. The FLIGHT-2 can be used on both 12V and 24V without the use of any pre-regulators. Ensure that the supply voltage will not drop below 8V during operation as this may result in incorrect readings.

### 10.9 Pressure Port Dimensions

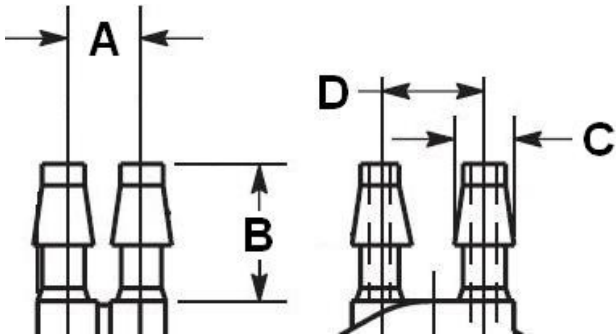

	Inches		Millimeters	
	Min	Max	Min	Max
<b>A</b>	0.248	0.278	6.30	7.06
<b>B</b>	0.420	0.440	10.67	11.18
<b>C</b>	0.182	0.194	4.62	4.93
<b>D</b>	0.310	0.330	7.87	8.38

## 11 Warranty

This product carries a warranty for a period of one year from date of purchase against faulty workmanship or defective materials, provided there is no evidence that the unit has been mishandled or misused. Warranty is limited to the replacement of faulty components and includes the cost of labor. Shipping costs are for the account of the purchaser.

**Note:** Product warranty excludes damages caused by unprotected, unsuitable or incorrectly wired electrical supplies and or sensors, and damage caused by inductive loads.

## 12 Disclaimer

Operation of this instrument is the sole responsibility of the purchaser of the unit. The user must make themselves familiar with the operation of this instrument and the effect of any possible failure or malfunction.

This instrument is not certified by the FAA. Fitting of this instrument to certified aircraft is subject to the rules and conditions pertaining to such in your country. Please check with your local aviation authorities if in doubt. This instrument is intended for ultralight, microlight, homebuilt and experimental aircraft. Operation of this instrument is the sole responsibility of the pilot in command (PIC) of the aircraft. This person must be proficient and carry a valid and relevant pilot's license. This person has to make themselves familiar with the operation of this instrument and the effect of any possible failure or malfunction. Under no circumstances does the manufacturer condone usage of this instrument for IFR flights.

The manufacturer reserves the right to alter any specification without notice.

## Other instruments in the *Stratomaster Velocity* series

<b>ALT-3</b>	Encoding aviation altimeter and Vertical speed indicator (VSI)
<b>ALT-4</b>	Encoding aviation altimeter with Serial RS232 & Parallel Gillham code output
<b>ASI-3</b>	Airspeed indicator (ASI) with automatic flight log
<b>ASX-2</b>	Encoding aviation altimeter and Airspeed indicator (ASI)
<b>AV-2</b>	Artificial horizon and magnetic compass indicator
<b>E-1</b>	Universal engine monitor
<b>FLIGHT-2</b>	Primary Flight instrument
<b>FF-3</b>	Fuel Computer (single or dual fuel tanks)
<b>GF-2</b>	+/-10G tilt compensated dual range G-force meter
<b>MAP-2</b>	Manifold pressure and RPM Indicator
<b>ROTOR-1</b>	Dual Rotor / Engine tachometer
<b>RTC-1</b>	Aviation real time clock (RTC), outside air temperature (OAT) and Voltage display
<b>RV-3</b>	Universal engine / Rotor RPM Indicator
<b>TC-2</b>	4-Channel thermocouple (EGT/CHT) indicator
<b>TC-3</b>	12-Channel thermocouple (EGT/CHT) indicator
<b>TP-2</b>	Universal temperature and pressure gauge